

WE O[®]

TECHNICAL GUIDE



Fiberdeck[®]

WEO[®]

CLASSIC

Wood plastic cladding
with natural look !

WEO[®] Classic is a coextruded composite wood cladding that looks like a real exotic wood siding.



It has the advantage of not fading over time and of being insensitive to moisture thanks to a waterproof polyethylene film covering its entire surface.

Composed of bio-based materials: 65% wood and 35% recycled plastics, the WEO Classic cladding boards are 100% recyclable.

The installation is made by invisible stainless steel clips in horizontal direction. Finishing profiles such as corner angles and U-shaped starter rails are available to facilitate installation. Installation can be made on any support: wood, aluminum, timber frame constructions, with or without insulation from the outside.

Finally, the WEO Classic boards all have a very successful wood appearance with intense and matt colors. Variations of multi-chromatic colors within a single board give rhythm to the facade and an inimitable warm appearance.



FINISHING PROFILES & ACCESSORIES



WEO® Classic 160 board
13 x 173 mm x 3.6 M | 6,0 kg (pce)
(usable surface = 0,576m²)

 Teak
Ref 1082
 Ipe
Ref 1083

 Silver
Ref 1084
 Ardoise
Ref 1085



U shaped starter (2 pcs)
25 x 0,7 mm x 3 m

 Aluminium
Ref 1090



F finishing profile (2 pcs)
35 x 45 mm x 3,60 m | 3,24 kg (pce)

 Teak
Ref 1086
 Ipe
Ref 1087

 Silver
Ref 1088
 Ardoise
Ref 1089



WEO® Classic hidden
fastener 100 pcs + screws
1,2 kg (pce)

 Aluminium
Ref 1091

WEO® screws for
aluminium profile

 Aluminium
Ref 1113



Finishing screw STRUCTURAL
4,5 x 40 mm

 Grey
Ref 0690

 Brun
Ref 0691



10 ESSENTIALS POINTS



1 STORAGE & HANDLING

Composite wood is sensitive to creep.

- > The boards must always be stored flat. During warehousing of board pallets, please make sure they are supported along their entire length
- > Keep the tarpaulin on the pallets during work as a protection.
- > Avoid placing loads on board pallets.
- > Carry boards one by one or two by two on their edges.

2 TOOLS

- > Radial arm saw on table.
- > Power screwdriver equipped with an T15 bit (bit not provided | the hidden fasteners box)



3 BATTENS

- > Horizontal installation: Calibrated battens Class 2 with minimum section of 27 x 40 mm.
- > Dual battens at each board junction.
- > Spacing of brackets: 60 cm.

4 CUTTING

- > Each board must be calibrated before installation. They may have an oversize of 10 mm. It is therefore important to cut them to the desired dimension in order to have clean joints.

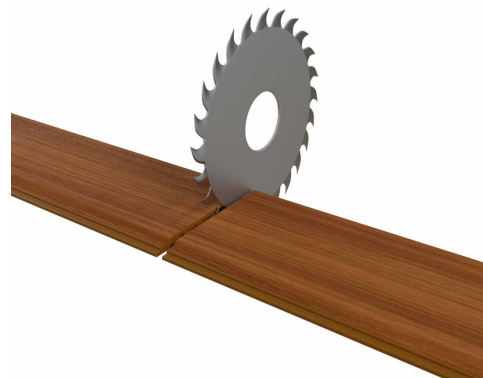



5 VENTILATION

- > Ground clearance: 150 mm.
- > High and low ventilation (parapet, shutter piece & window head 15 mm).
- > Air space between wall and covering : minimum 20 mm

6 FASTENING ON WOODEN SUPPORTS

Stainless steel screw A2 (AISI304) - 4x25mm
Wood thread Torx recess T15

- > Head \varnothing 8.5 mm
- > Nominal body diameter \varnothing 4mm
- > Length under head : L = 25mm
- > Every junction between 2 boards ends :
Install 2 hidden fasteners side to side

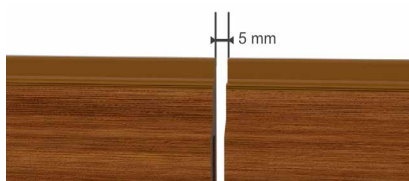
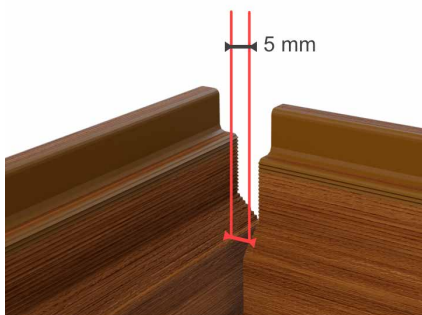

7 DILATATION

> WEO® boards have a coefficient of expansion of 1 mm/lm (for a temperature gradient of 40°C). Example: a 3.6 m board exposed to a temperature of 5°C in the morning and 40°C in the afternoon will expand by 3.15 mm.

Between each board end and for all types of obstacles encountered (joinery work, wall, corner, board, etc.), ensure clearance of 5 mm.

8 DIRECTION OF BOARD INSTALLATION

Horizontal installation: The assembly begins at the bottom of the facade with the starting profile for WEO CLASSIC. The starting profile is positioned horizontally. Screw so that the screw head does not block the placement of the first board. The planks are installed horizontally by mounting on clips spaced 600 mm apart.

The last board is fixed in the upper part using a 4x35mm screw visible on each battens. The screw should be placed 18mm minimum from the edge to avoid cracking the board.

Vertical installation: WEO® Classic cladding boards are installed on wooden rafters with a cross-section of 40x60mm, spaced at maximum 600 mm apart. A double grid will be required. The wooden rafters of the first grid will be fixed vertically to the support and the wooden rafters of the second grid will be fixed horizontally to those of the first grid. The boards are fixed to the studs with WEO Classic clips by interlocking. The WEO Classic clips are fixed to the wooden uprights with a 4x25mm wood screw (Torx T15). At each end of the boards and every 2 clips, the WEO Classic boards must be reinforced by screwing in a 4.5x40mm screw that is coloured to match the colour of the boards. The screwing is carried out in the thickest part of the tongue. The butt joint between the boards is always made at a jamb. The space between two boards must be 5mm to allow for expansion in response to changes in temperature and humidity and the wooden backing on the back must be protected by an EPDM sealing strip. The edge guards of the upright should be at least 18 mm. The first boards at the bottom must rest on the starter profile.



9 FINISHES

- > We recommend use of painted aluminium profiles to make finishes.
- > All of the necessary finish profiles for the creation of angle corners, cladding end covers, reveals, and vertical or horizontal expansion joints are detailed in this installation guide.
- > The drawings are provided in accordance with the characteristics to follow, and some components have variable dimensions to be adapted as a function of the structure. Profiles must be manufactured upon request by thin metal sheet folding specialists, taking into account the specificities of the structure.

10 WEATHERING & MAINTENANCE

The polyethylene protective film from the co-extrusion process guarantees UV resistance for 20 years without any apparent fading. Cleaning with water (high-pressure washer) can be done as a function of façade exposure and dirt deposits.

CHARACTERISTICS OF WEO® CLADDING

1 - DESCRIPTION OF WEO® CLADDING

WEO® Classic cladding is a siding system, in accordance with standard EN 15534.

WEO® Classic cladding is a bio-based eco-material. It is 95% recycled and is 100% recyclable. Wood, the majority component with more than 60% of its composition, and polymer (HDPE) result from reprocessing of waste.

The installation of the boards is done horizontally by interlocking on stainless steel clips, fixed on a wooden battens frame or aluminum beams secured to the supporting structure by adjustable angle brackets or fixed directly on the support.

There is a ventilated air space, 20 mm minimum, between the inner face of boards and the bare exterior of the load-bearing wall or any heat insulation.

WEO® Classic cladding has a matt brushed surface, with multi-chromatic pigmentation. The boards are available in 4 colors: Ipe, Teak, Ardoise, Silver.

2 - DIMENSIONAL SPECIFICATIONS

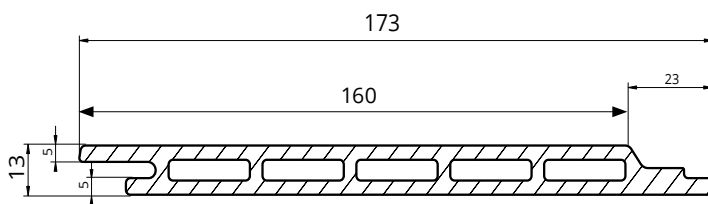

Board surface (effective)	0,576m2
Area density	10,3 kg/m2
Total width	173 mm
Effective width	160 mm
Length	3600 mm

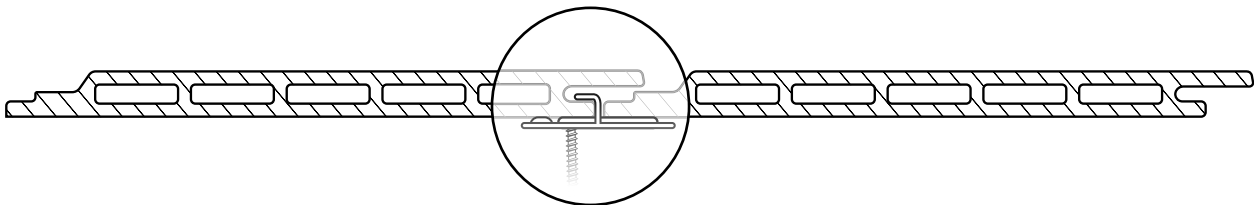

	Quantity of clips / m2	Quantity of clips / board of 3,6 m
Span 60 cm	11	7

1 - RANGE **09**

2 - HORIZONTAL INSTALLATION ON ALL SUPPORTS **10**

- 2.1 GENERAL VIEW
 - 2.2 FOOT OF WALL AND PARAPET
 - 2.3 WINDOW HEAD AND SILL
 - 2.4 INSIDE CORNER WITH JOINT COVER
 - 2.4.1 INSIDE CORNER WITHOUT JOINT COVER
 - 2.5 STAGGERED INSTALLATION
 - 2.5.1 STRAIGHT INSTALLATION
 - 2.6 SEPARATION AND AIR SPACE CUT-OFF
 - 2.7 CLADDING END COVER
 - 2.8 VERTICAL EXPANSION JOINT
 - 2.9 REPLACEMENT OF A BOARD
-

3 - INSTALLATION ON WOODEN FRAMEWORK STRUCTURE **19**

4 - INSTALLATION ON METAL FRAMEWORK **20**

5 - VERTICAL INSTALLATION ON ALL SUPPORTS **21**

- 5.1 OVERVIEW
- 5.2 DEPARTURE AND ACROTERION
- 5.3 OUTWARD ANGLE
- 5.4 INWARD ANGLE
- 5.5.1 STAGGERED INSTALLATION
- 5.5.2 STRAIGHT INSTALLATION
- 5.6 AIR GAP SPLITTING AND CUTTING
- 2.7 CLADDING EDGE
- 5.8 EXPANSION



1- RANGE

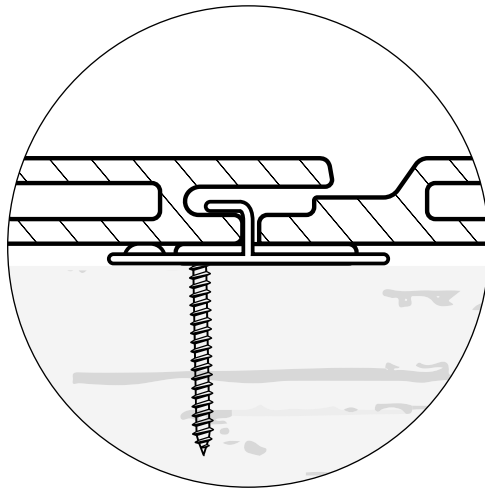
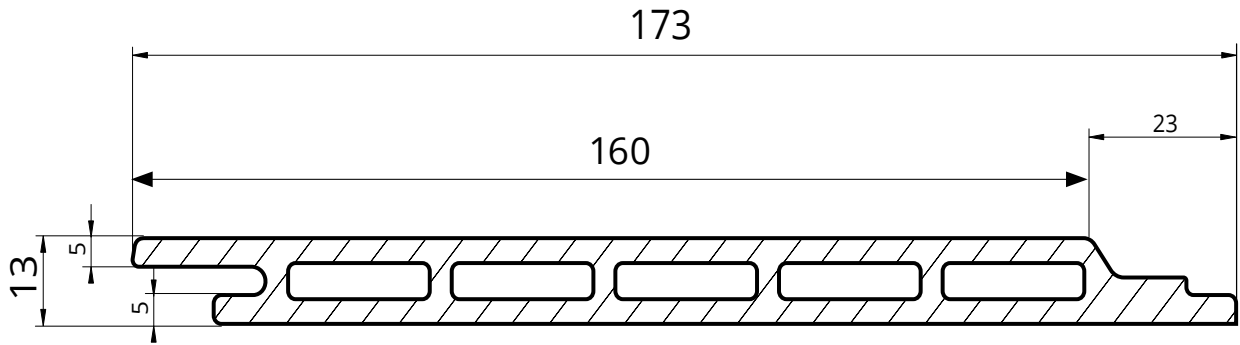

Hidden fastener installation

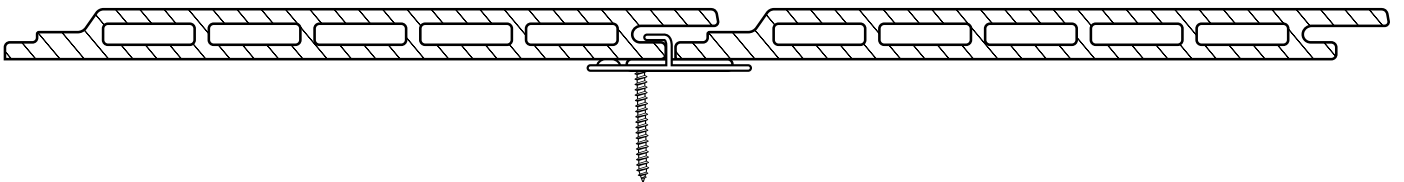



2 - HORIZONTAL INSTALLATION ON ALL SUPPORTS

2.1 - GENERAL VIEW



WITHOUT ITE

WITH ITE

2 - HORIZONTAL INSTALLATION ON ALL SUPPORTS

2.2 - FOOT OF WALL AND PARAPET

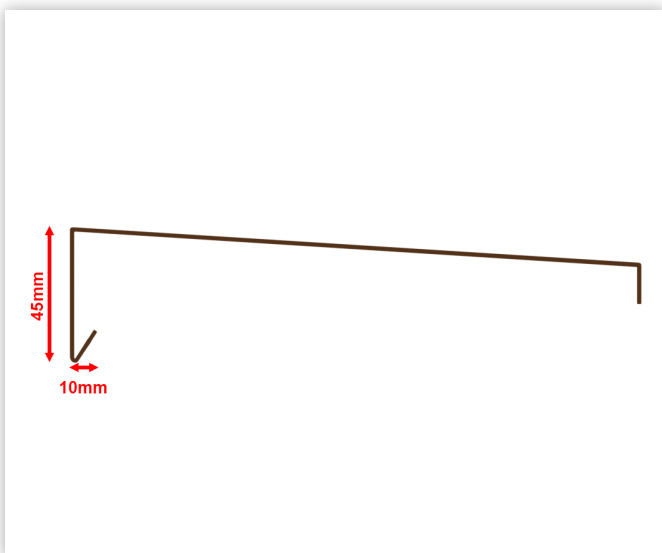
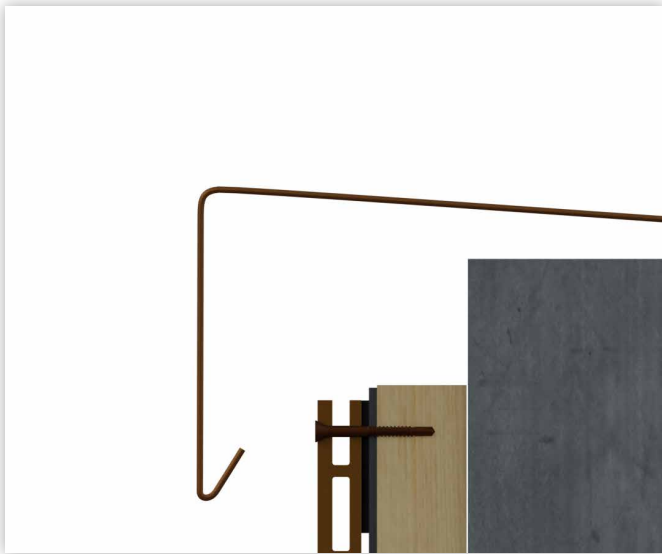

2 - HORIZONTAL INSTALLATION ON ALL SUPPORTS

2.3 - WINDOW HEAD AND SILL

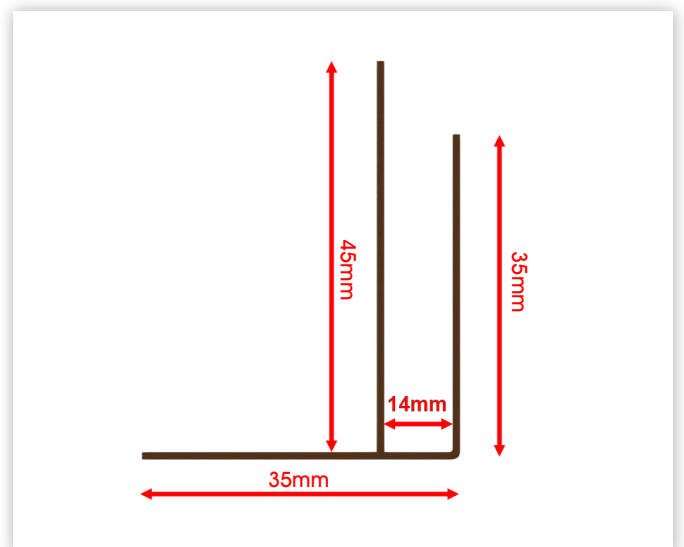
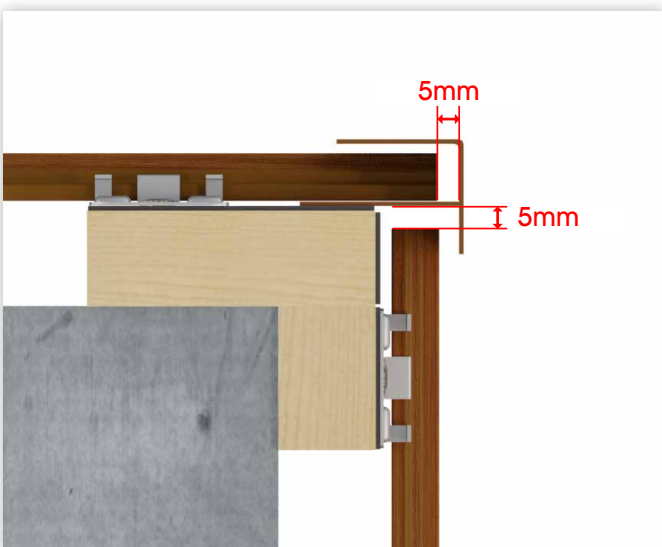
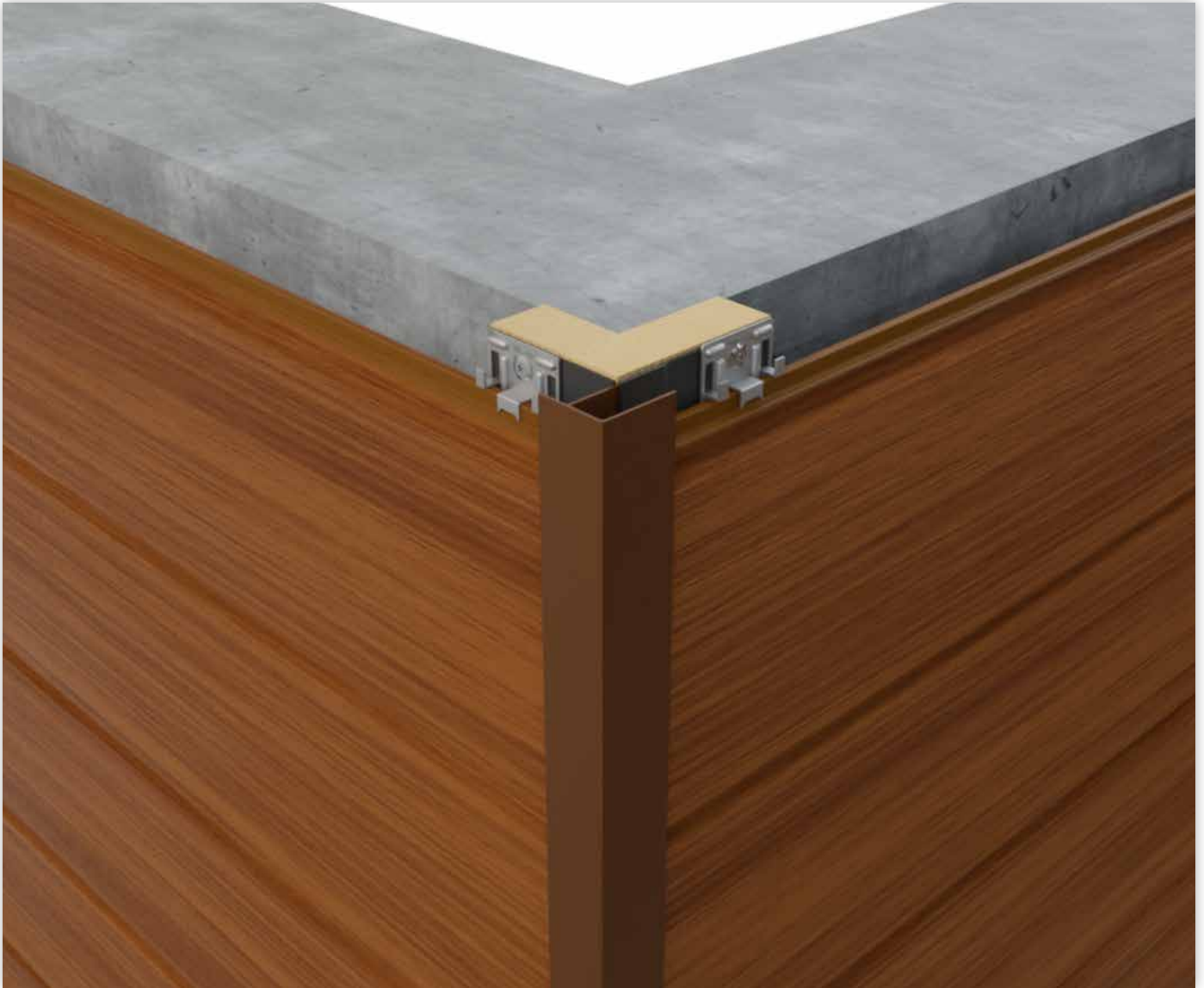

2 - HORIZONTAL INSTALLATION ON ALL SUPPORTS

2.4 - INSIDE CORNER WITH JOINT COVER

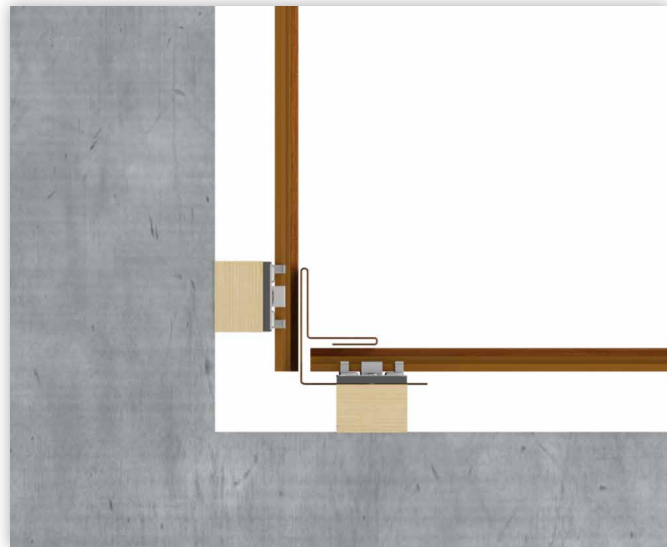
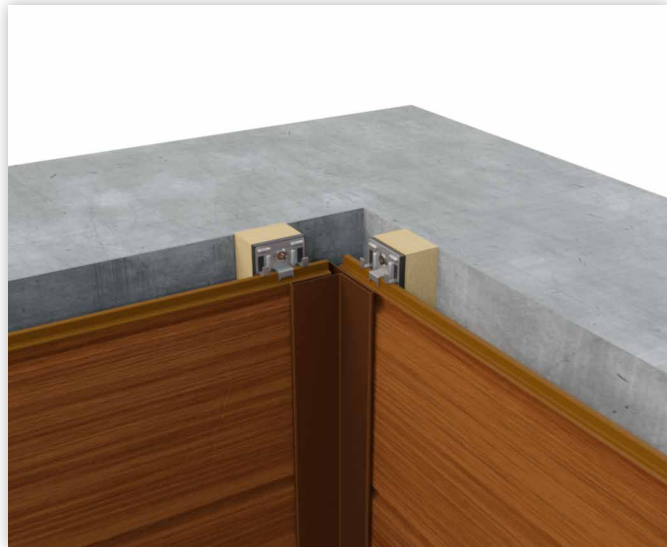

2.4.1 - INSIDE CORNER WITHOUT JOINT COVER

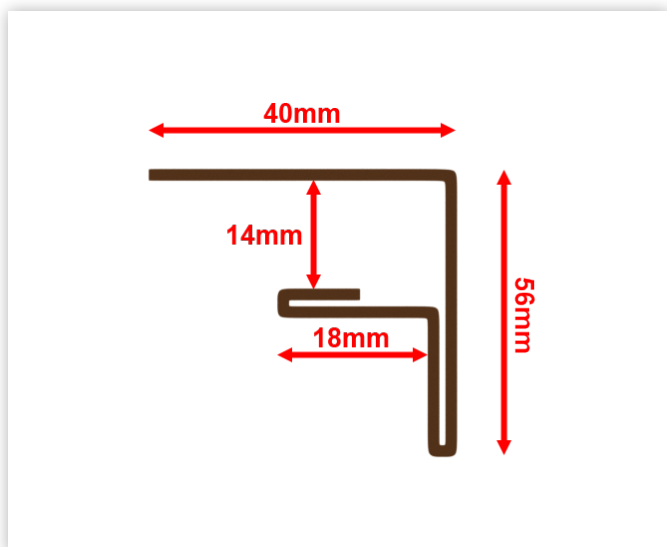
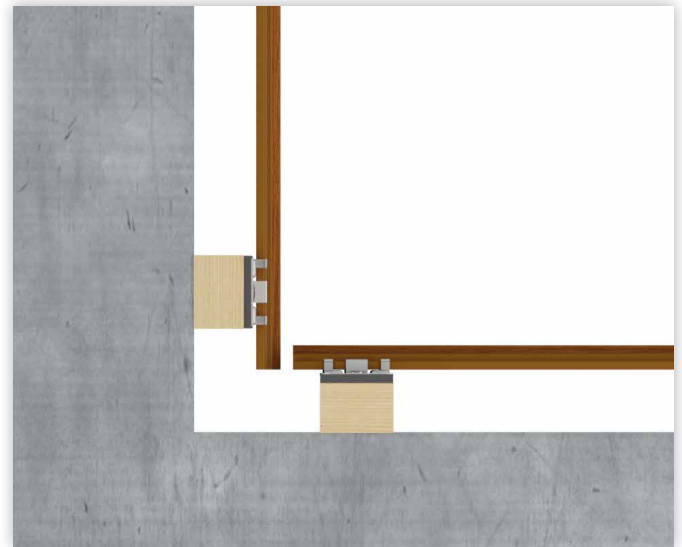

2 - HORIZONTAL INSTALLATION ON ALL SUPPORTS

2.5 - STAGGERED INSTALLATION



2.5.1 - STRAIGHT INSTALLATION

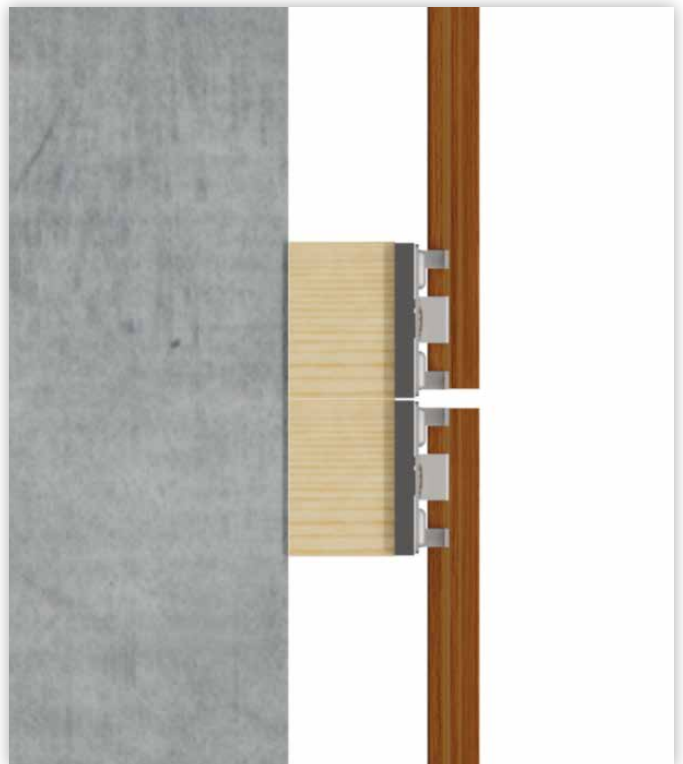
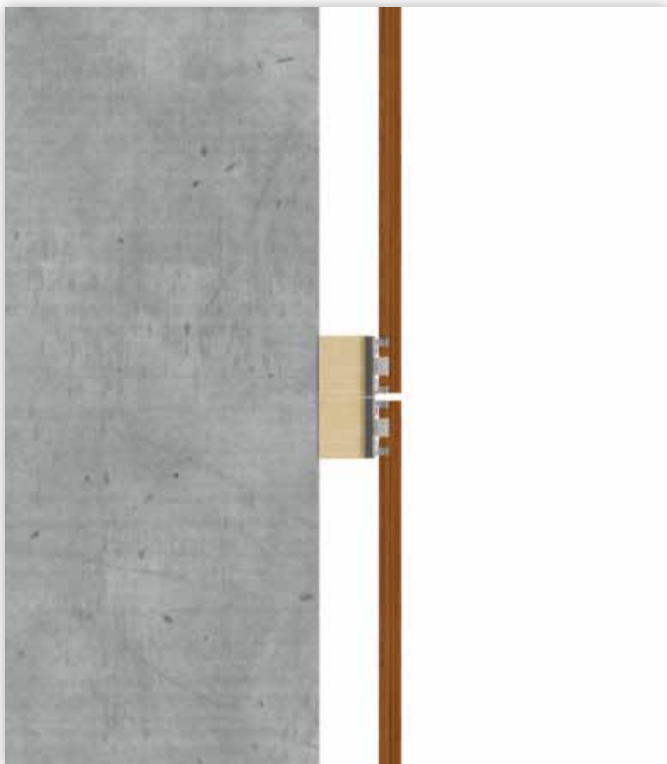

2 - HORIZONTAL INSTALLATION ON ALL SUPPORTS

2.6 - SEPARATION AND AIR SPACE CUT-OFF

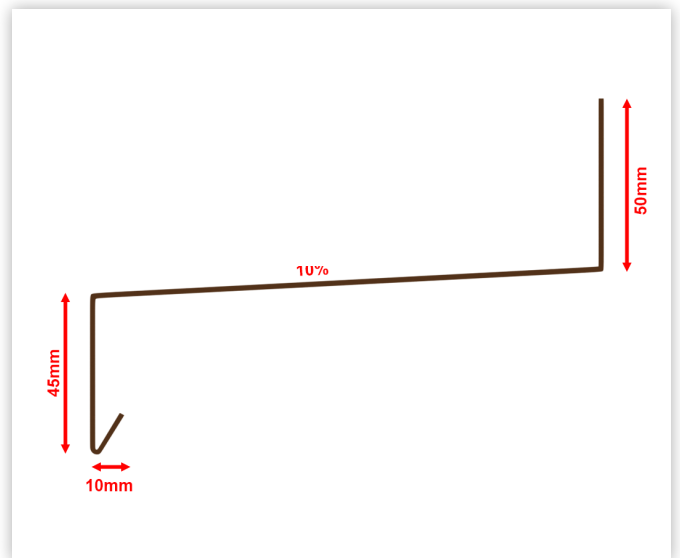
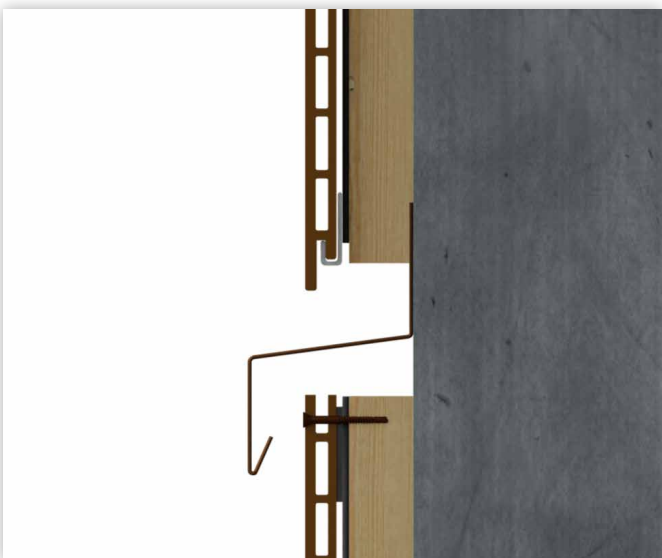

2 - HORIZONTAL INSTALLATION ON ALL SUPPORTS

2.7 - CLADDING END COVER

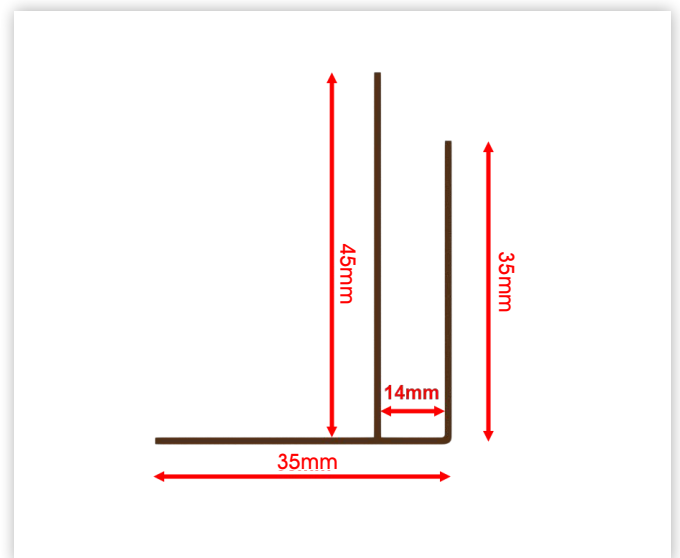
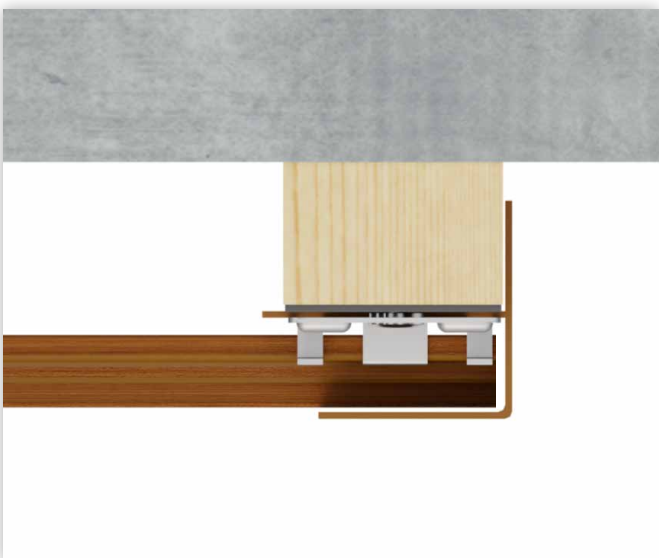

2 - HORIZONTAL INSTALLATION ON ALL SUPPORTS

2.8 - VERTICAL EXPANSION JOINT

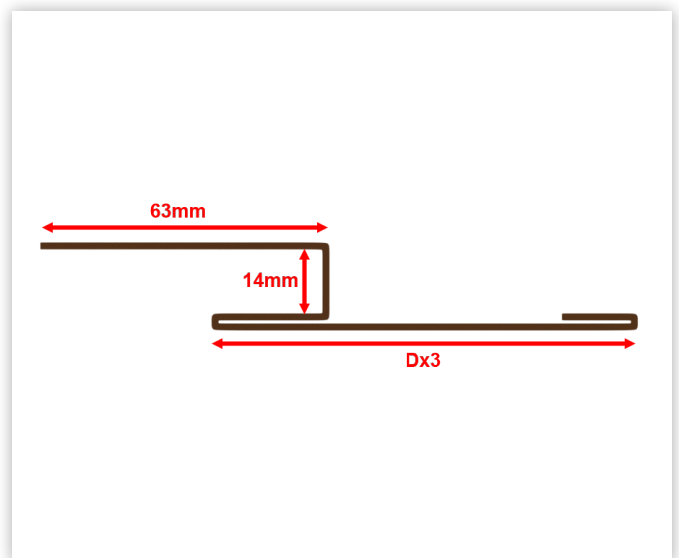
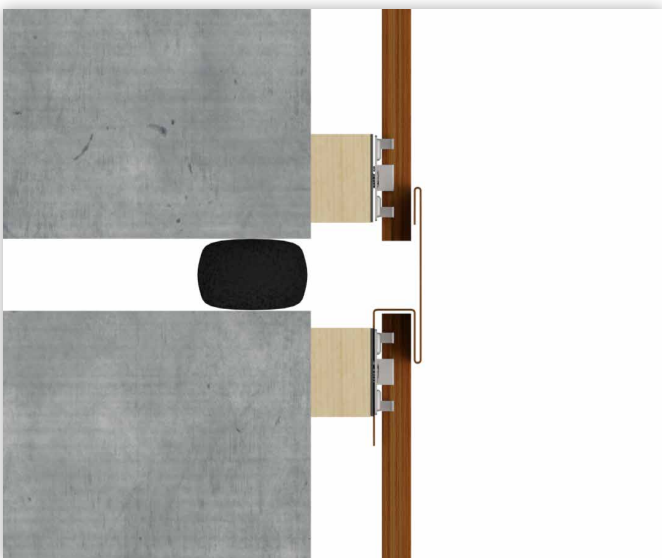
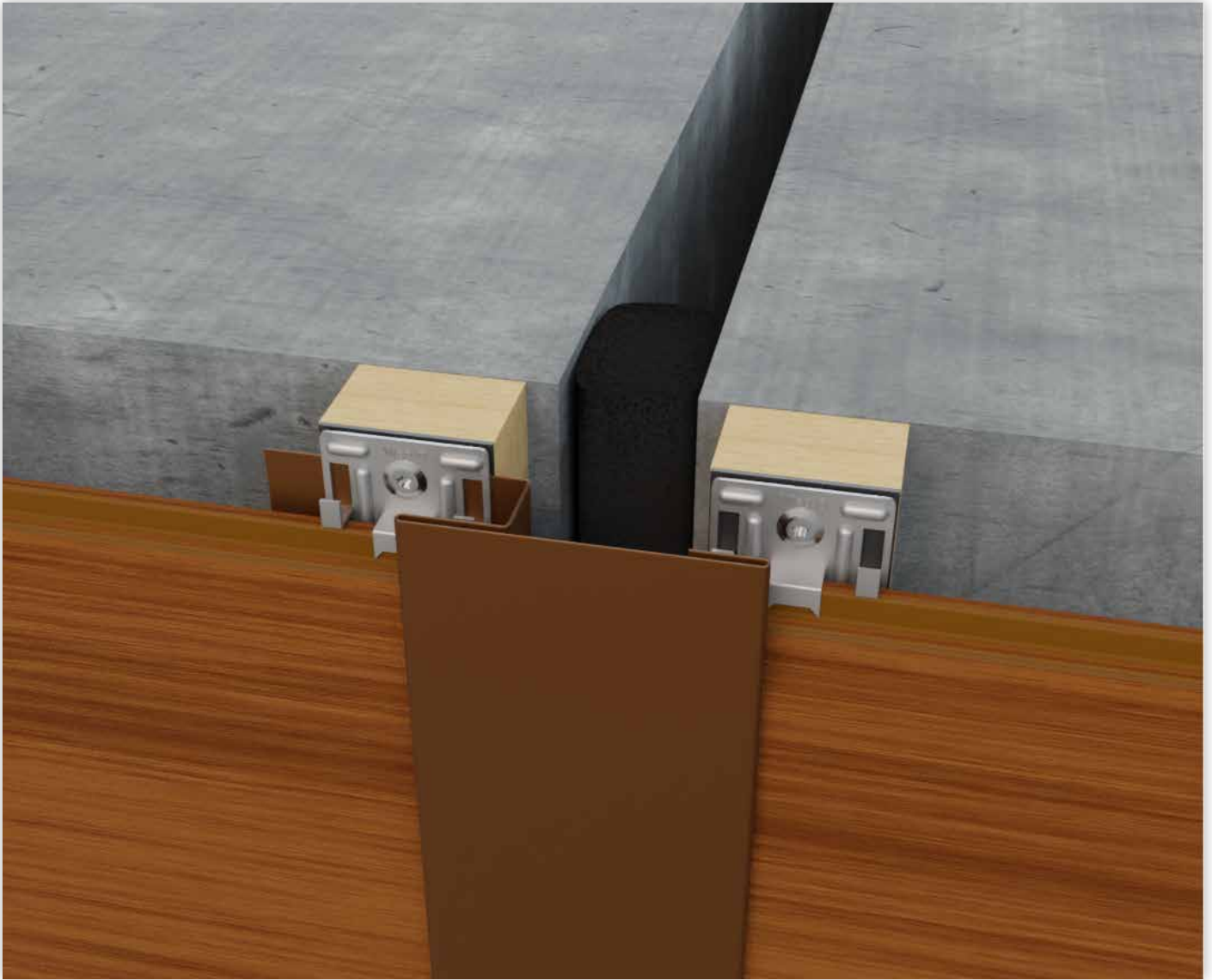

2 - HORIZONTAL INSTALLATION ON ALL SUPPORTS

2.9 - REPLACEMENT OF A BOARD

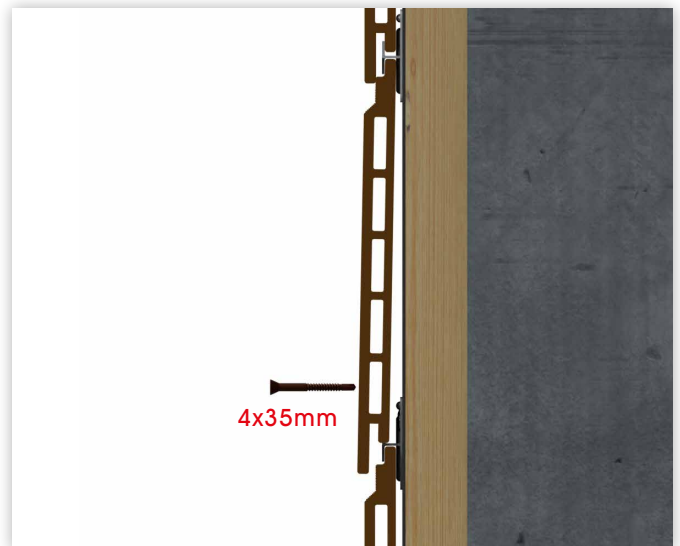
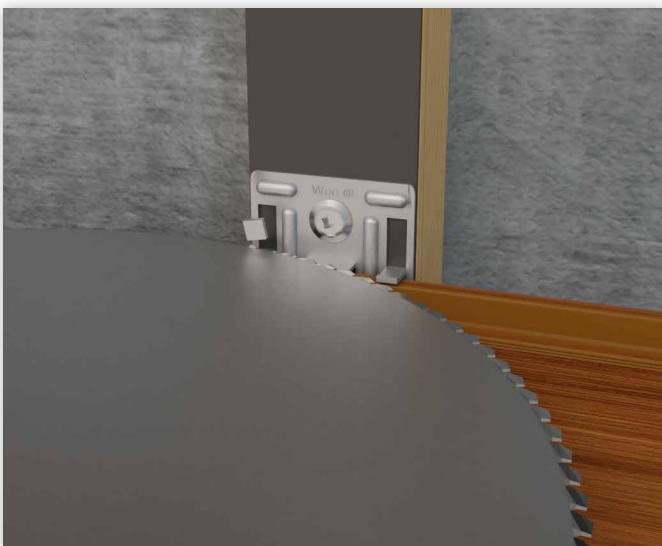
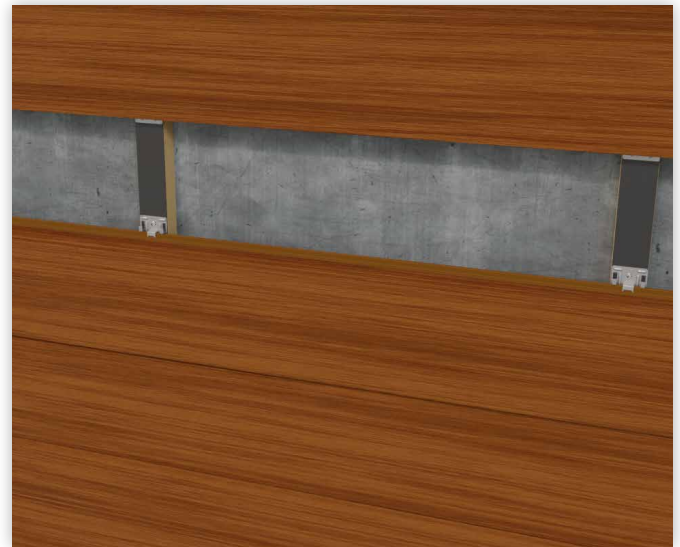
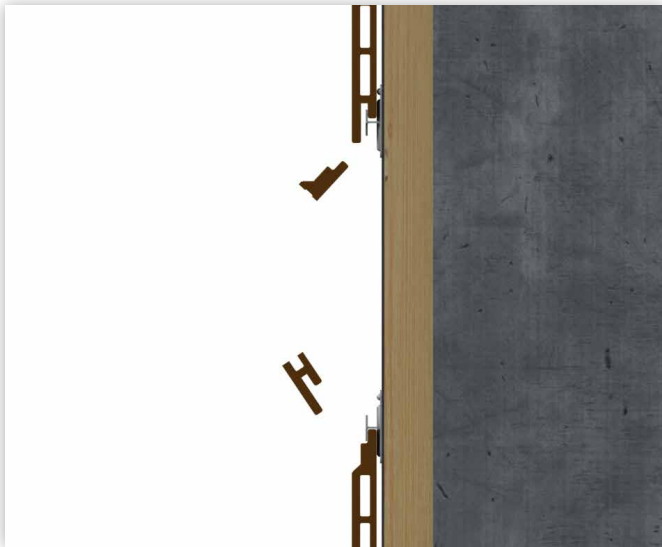
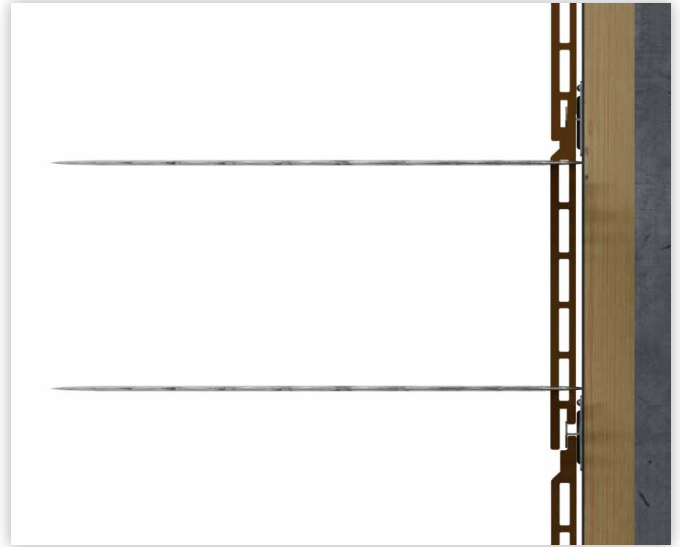
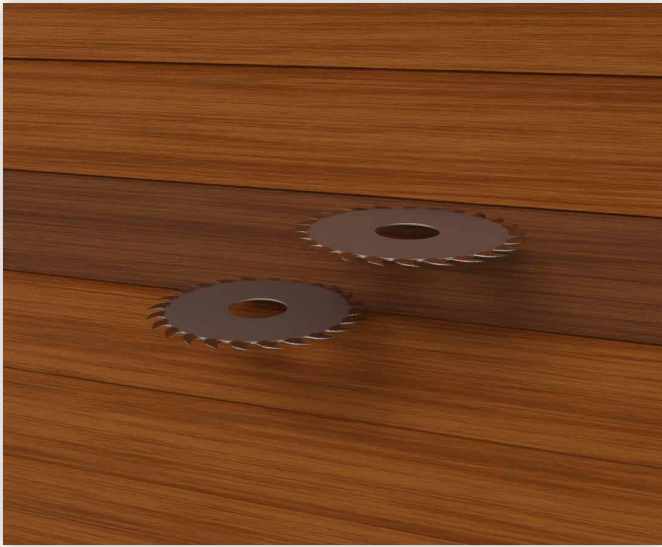

3 - INSTALLATION ON WOODEN FRAMEWORK STRUCTURE

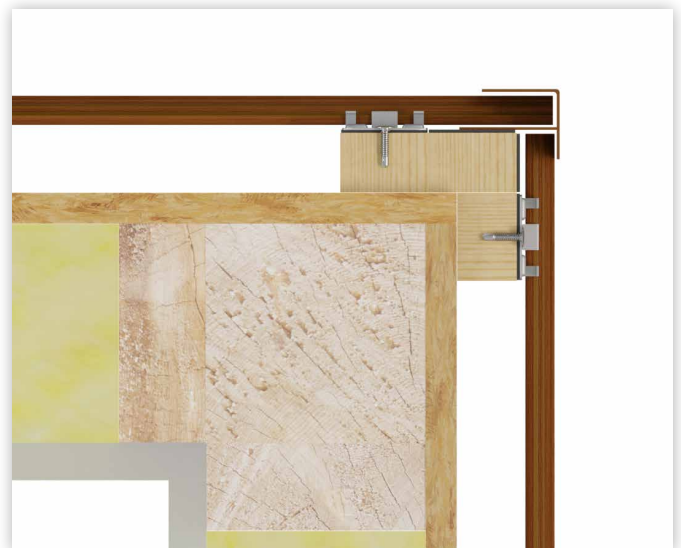
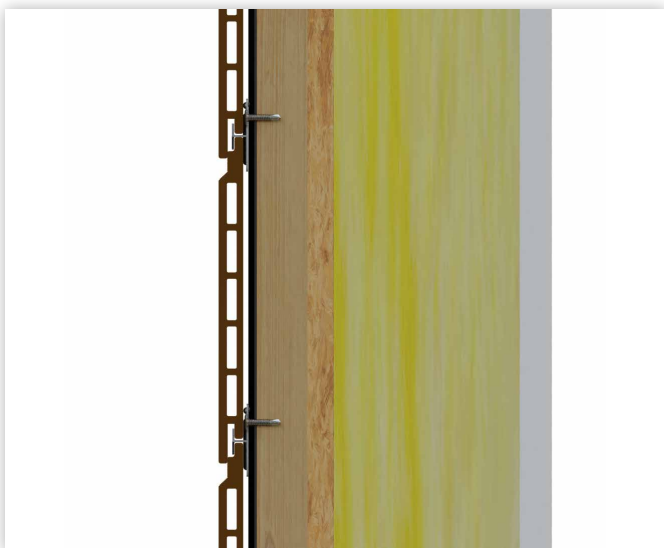
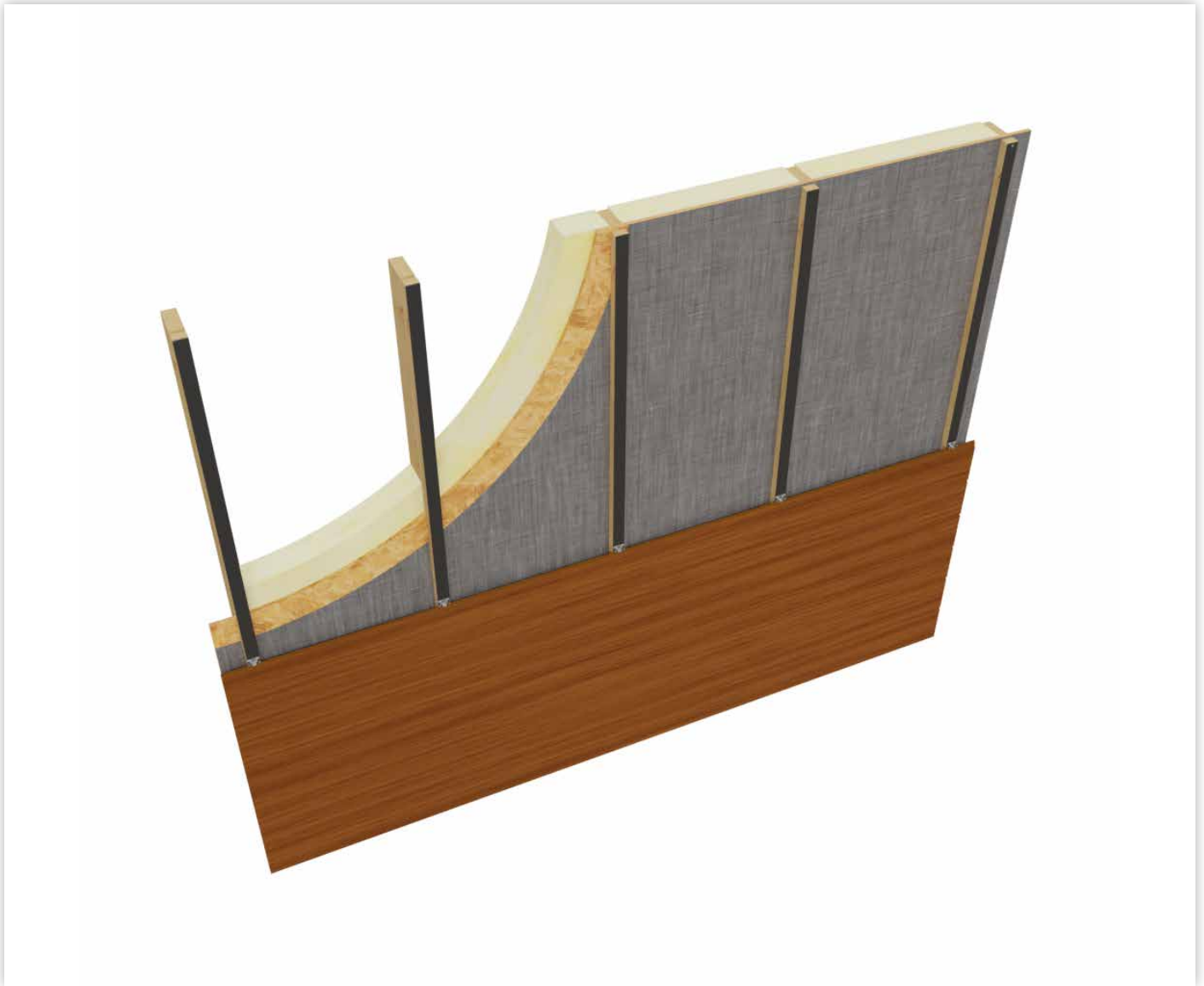

4 - INSTALLATION ON METAL FRAMEWORK

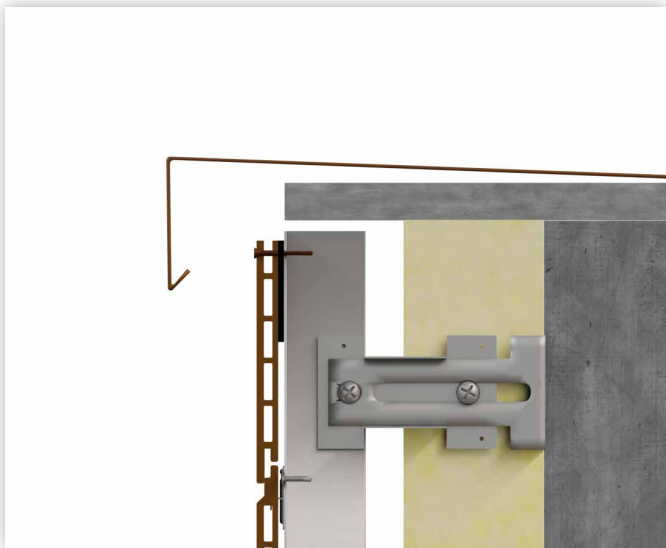
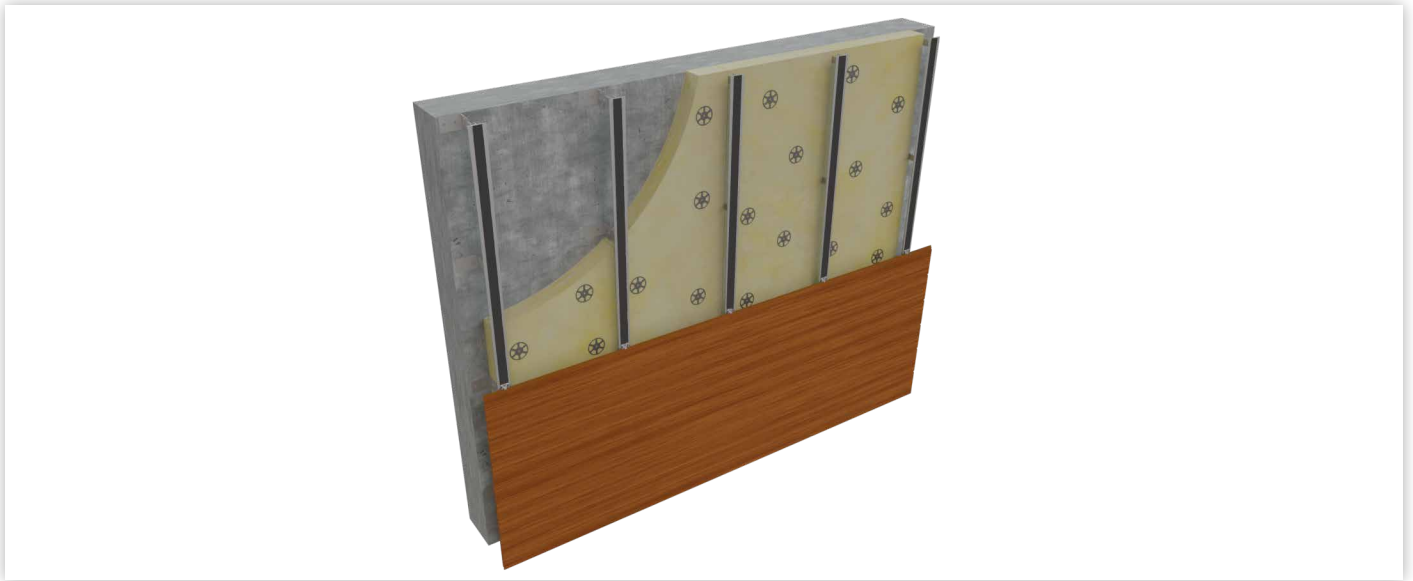



5 - VERTICAL INSTALLATION ON ALL SUPPORTS

5.1 - OVERVIEW

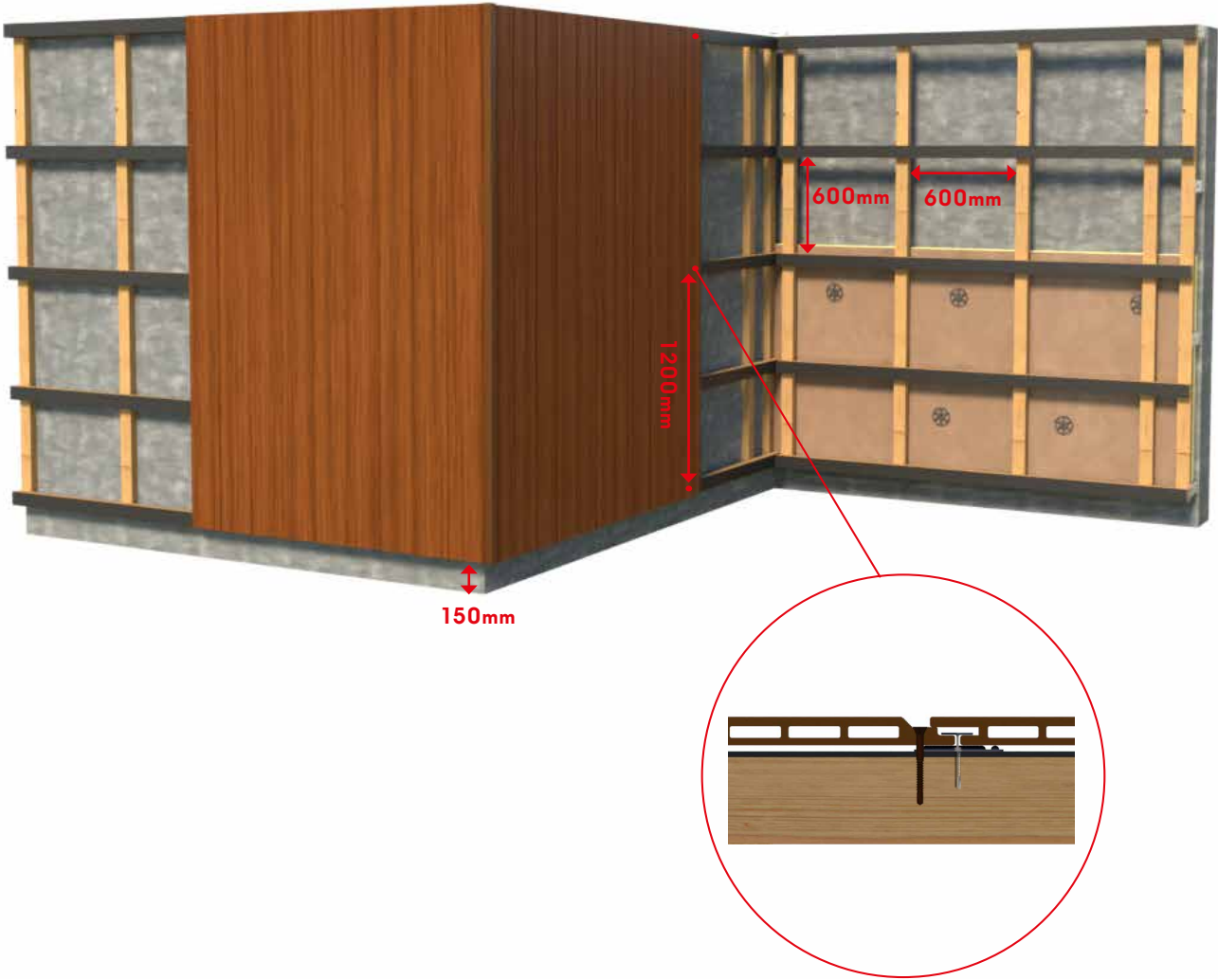

5 - VERTICAL INSTALLATION ON ALL SUPPORTS

5.2 - DEPARTURE AND ACROTERION

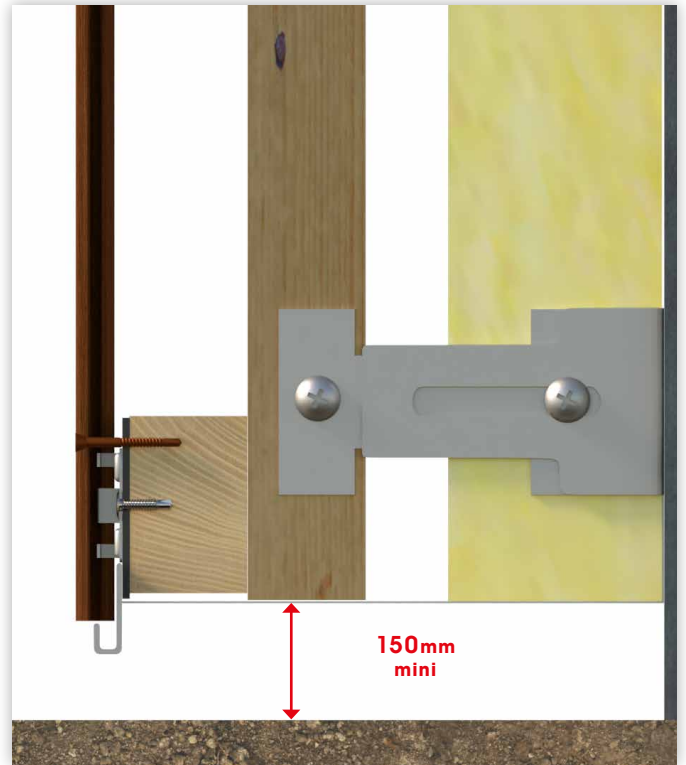
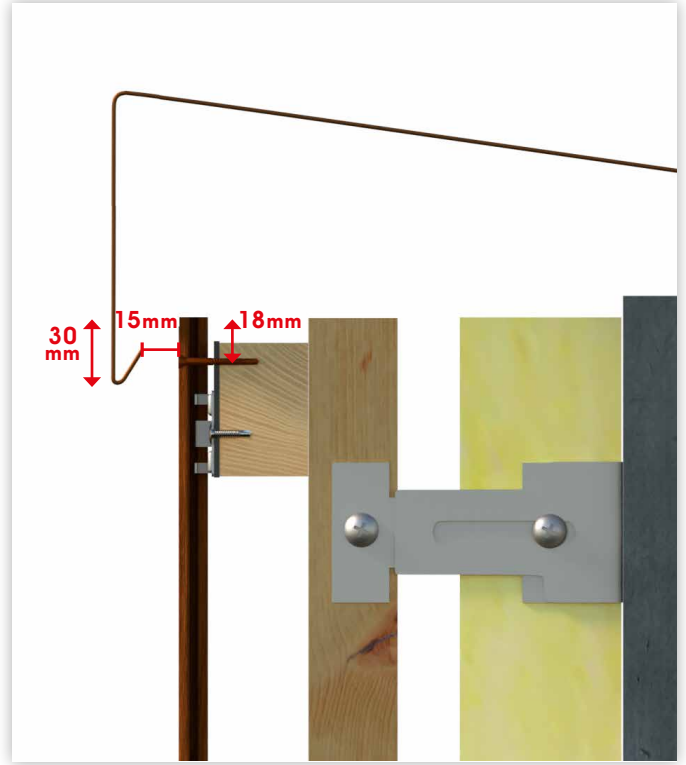

5 - VERTICAL INSTALLATION ON ALL SUPPORTS

5.3 - OUTWARD ANGLE



5.4 - INWARD ANGLE

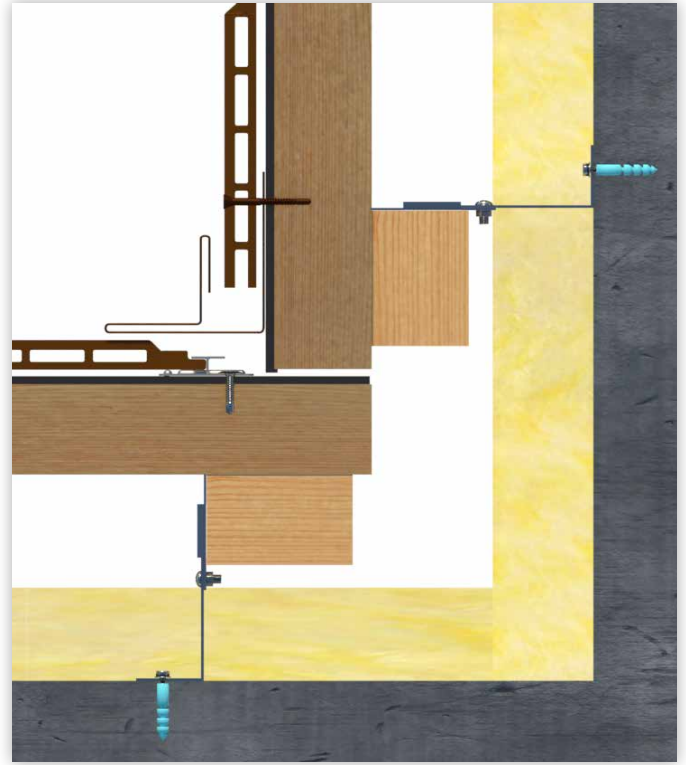

5 - VERTICAL INSTALLATION ON ALL SUPPORTS

5.5.1 - STAGGERED INSTALLATION

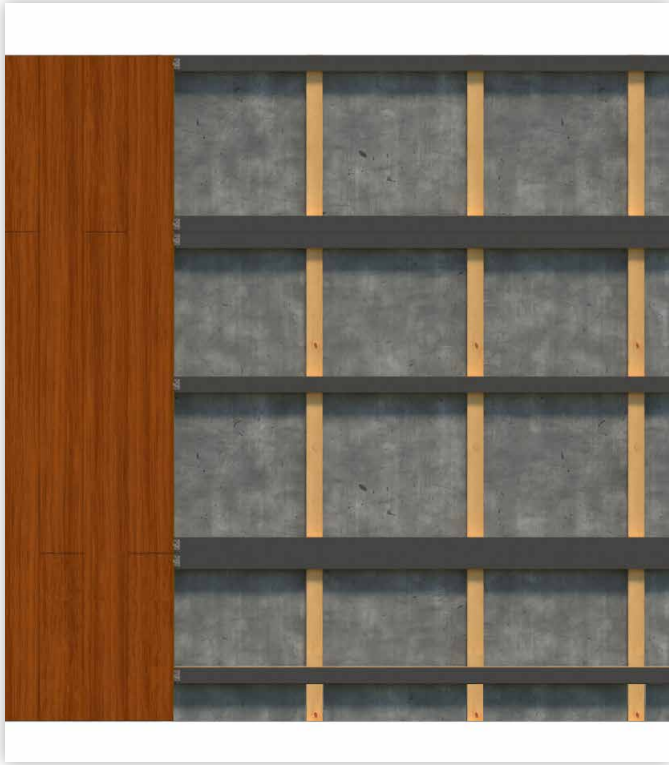

5.5.2 - STRAIGHT INSTALLATION

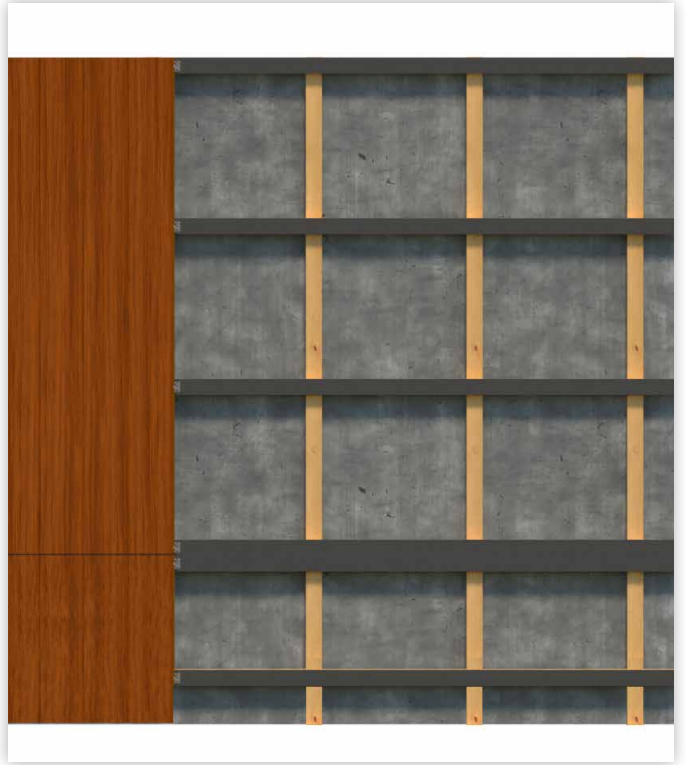

5 - VERTICAL INSTALLATION ON ALL SUPPORTS

5.6 - AIR GAP SPLITTING AND CUTTING

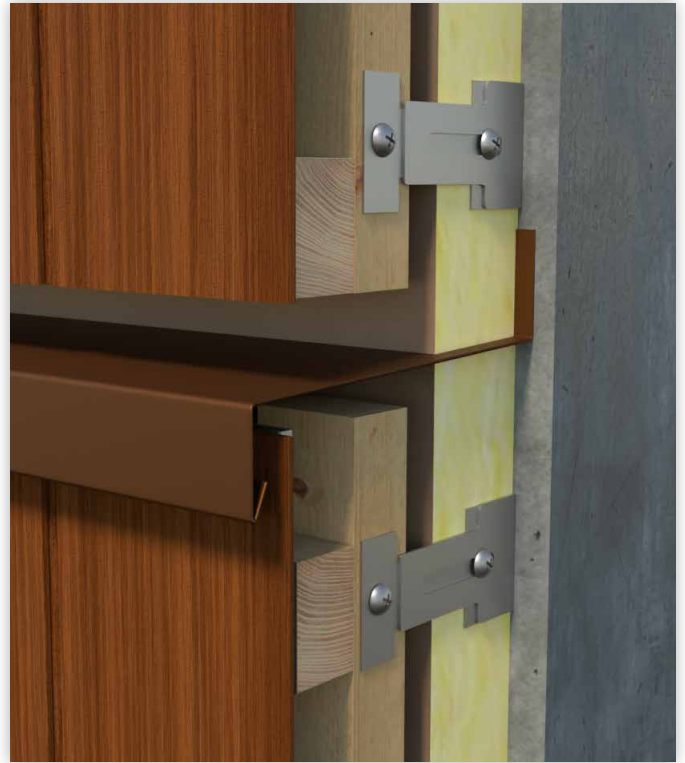
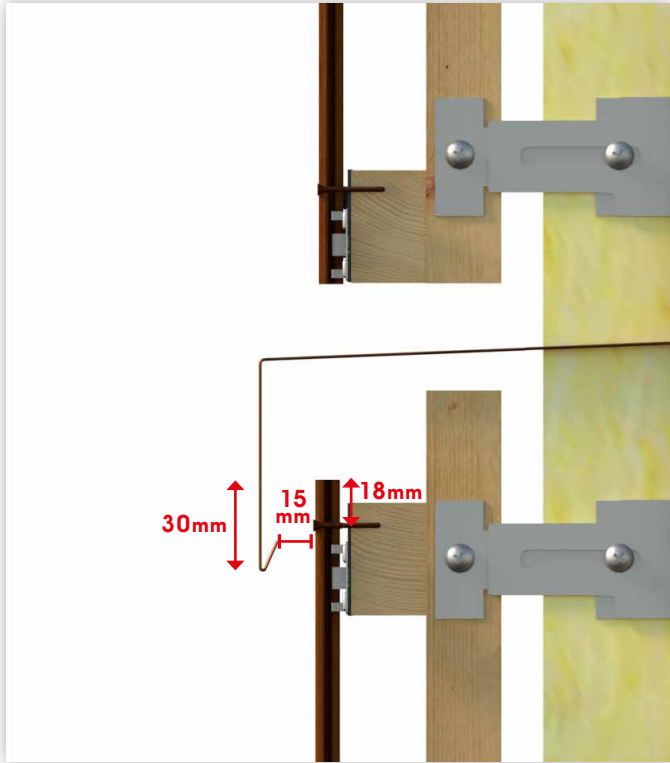



5 - VERTICAL INSTALLATION ON ALL SUPPORTS

5.7 - CLADDING EDGE



5 - VERTICAL INSTALLATION ON ALL SUPPORTS

5.8 - EXPANSION

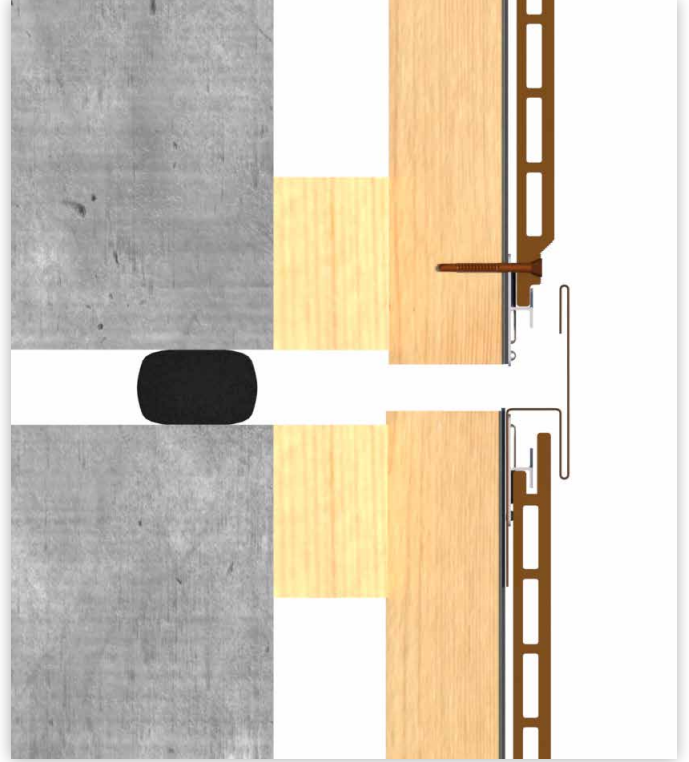

Fiberdeck[®]

www.fiberdeck.com