

WEO®

TECHNICAL GUIDE



Fiberdeck®



WEO® has a trapezoidal profile for both horizontal and vertical installation

WEO® is an eco-friendly product manufactured with bio-sourced materials containing 95% recycled products. The boards are protected by a co-extruded polyethylene film, which prevents any moisture pick-up. It is also not sensitive to stains and discolouration

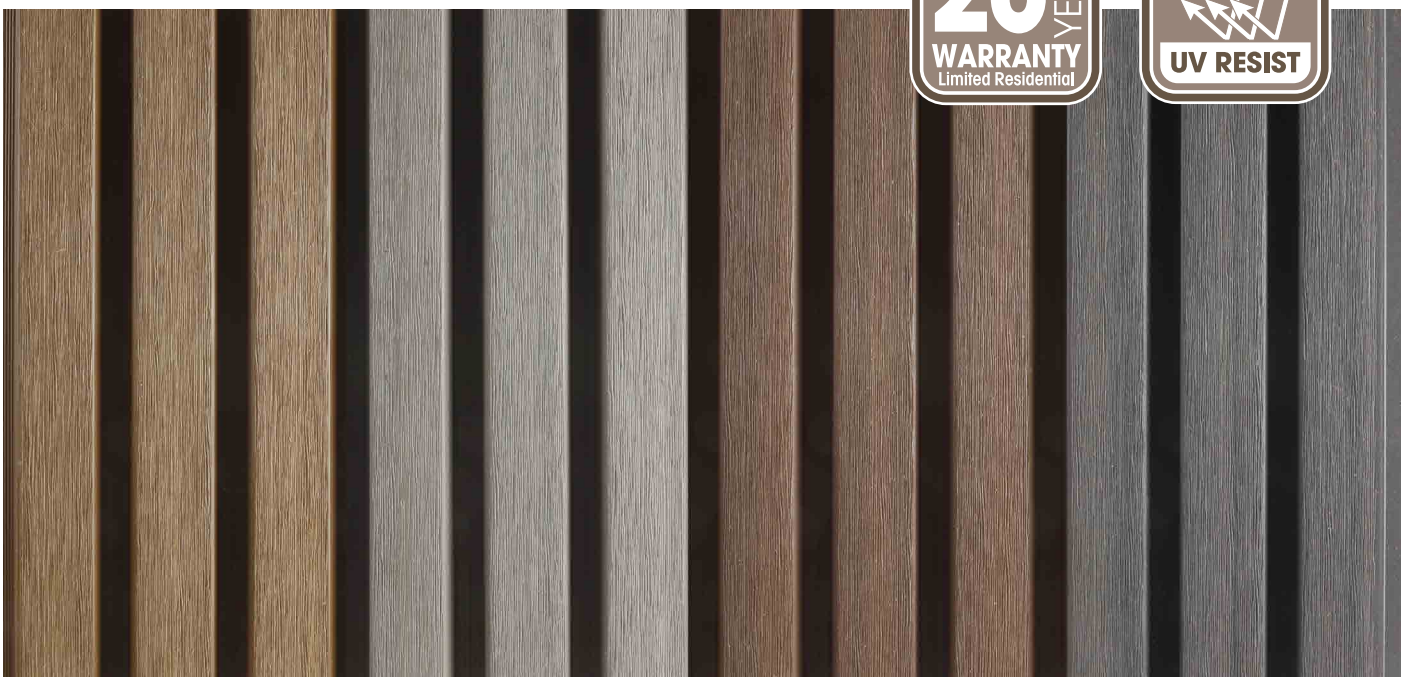

PROFILES & ACCESSORIES



WEØ 35

Co-extruded composite cladding board

33 x 170 x 3600 mm | 7,52 kg (unit)
(effective surface = 0,504 m²)



Teak
Ref 0942



Silver grey
Ref 0944



Ipe
Ref 0943

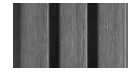

Slate
Ref 0945



WEØ 60

Co-extruded composite cladding board

33 x 170 x 3600 mm | 7,52 kg (unit)
(effective surface = 0,504 m²)



Teak
Ref 1078



Silver grey
Ref 1080



Ipe
Ref 1079

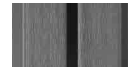

Slate
Ref 1081



SR2 stainless steel screws
-box of 500 parts + end piece

4,2 x 38 mm | 4,00 kg (unit)



Teak
RAL 8024
Ref 0946



Silver grey
RAL 7030
Ref 0948



Ipe RAL 8028
Ref 0947



Slate
RAL 7043
Ref 0949



F profile (2 units)

65 x 80 mm x 3,60 m
4,00 kg (unit)



Teak
RAL 8024
Ref 0967



Silver grey
RAL 7030
Ref 0969



Ipe RAL 8028
Ref 0968



Slate
RAL 7043
Ref 0970



10 ESSENTIAL POINTS

1 STORAGE & HANDLING

Composite wood is sensitive to creep.

- > The boards must always be stored flat. During warehousing of board pallets, please make sure they are supported along their entire length.
- > Keep the tarpaulin on the pallets during work as a protection.
- > Avoid placing loads on board pallets.
- > Carry boards one by one or two by two on their edges.



2 TOOLS

- > Radial arm saw on table.
- > Power screwdriver equipped with an SR2 type end-piece – (end-piece supplied with box of screws)



3 BRACKETS

- > Horizontal installation: Calibrated battens Class 2 with minimum section of 27 x 40 mm.
- > Vertical installation: Calibrated battens, fast-draining Class 2 with minimum section of 27 x 40 mm, or Class 3.
- > Dual battens at each board junction.
- > Spacing of brackets: 60 cm.

4 CUTTING

- > Each board must be calibrated before installation. They may have an oversize of 10 mm. It is therefore important to cut them to the desired dimension in order to have clean joints.





5 VENTILATION

- > Ground clearance: 150 mm.
- > High and low ventilation (parapet, shutter piece & window head 15 mm).
- > Air space between wall and covering: minimum 20 mm.

6 FASTENING ON WOODEN SUPPORTS

- > Self-drilling screw, stainless steel 304 - 4.2 x 38 mm - wood/aluminium thread.
- > crew colour matches cladding board colour.
 - > Cavity = SR2.
 - > Head \varnothing 8.0 mm.
 - > Body with diameter \varnothing 4.2 mm.
- > Length under head: L = 38 mm.
 - > Self-drilling tip.
 - > Anti-strip notching under head.

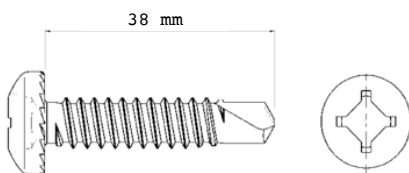
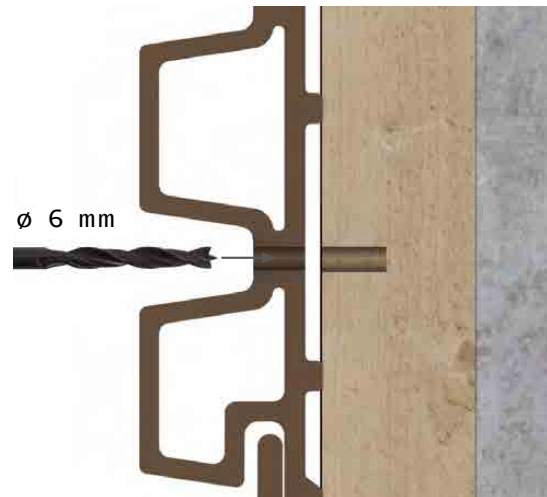

- 1 - Drilling \varnothing 6 mm.
 - 2 - Install one screw per board in a single groove base in the common part.
- Install 2 screws at each end.

Caution: the screw head must rest on the cladding board, but not exert any force on it, which could initiate cracking.

At the end of the board, allow a setback of 15 mm to avoid any risk of cracking

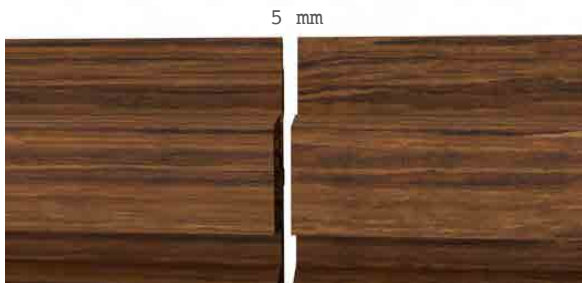

7 EXPANSION

> WEO® boards have a coefficient of expansion of 1 mm/lm (for a temperature gradient of 40°C). Example: a 3.6 m board exposed to a temperature of 5°C in the morning and 40°C in the afternoon will expand by 3.15 mm.

Between each board end and for all types of obstacles encountered (joinery work, wall, corner, board, etc.), ensure clearance of 5 mm.

> Between each board end and for all types of obstacles encountered (joinery work, wall, corner, board, etc.), ensure clearance of 5 mm.

8 DIRECTION OF BOARD INSTALLATION

Horizontal installation:

- > The groove should be in the low position and the tab in the high position.
- > 2 screws in 2 waves for the first board in the low part.

Vertical installation:

- > No specific direction.

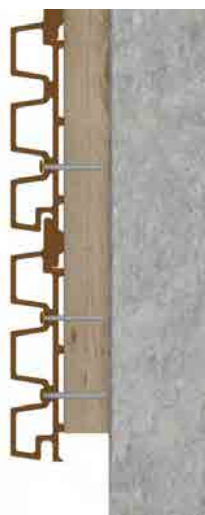

9 FINITIONS

> We recommend use of painted aluminium profiles to make finishes.

> All of the necessary finish profiles for the creation of angle corners, cladding end covers, reveals, and vertical or horizontal expansion joints are detailed in this installation guide.

> The drawings are provided in accordance with the characteristics to follow, and some components have variable dimensions to be adapted as a function of the structure. Profiles must be manufactured upon request by thin metal sheet folding specialists, taking into account the specificities of the structure.

10 AGEING & UPKEEP

The polyethylene protective film from the co-extrusion process guarantees UV resistance for 20 years without any apparent fading. Cleaning with water (high-pressure washer) can be done as a function of façade exposure and dirt deposits.

TECHNICAL DESCRIPTION

1 - DESCRIPTION OF WEO® CLADDING

WEO® cladding is a false open-joint cladding system that complies with the EN 15534 standard. It is designed from reconstituted wood, composed of 65% wood fibres (wood processing by-products) and 35% recycled polyethylene.

It has a brushed mat surface appearance, with multi-chromatic pigmentation.

Cladding boards are composed of 3 waves of 36 mm. They are offered in four colours: Teak, Ipe, Slate, Silver grey.

They can be installed in horizontal or vertical position on flat walls. Fastening is done at the bottom of the wave with painted head screws, in accordance with RAL colour chart approaching SFS type.

There is a ventilated air space, 20 mm minimum, between the inner face of boards and the bare exterior of the load-bearing wall or any heat insulation.

2 - SIZE CHARACTERISTICS

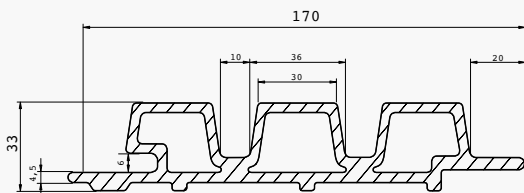

Surface area of a board (effective)	0,504 m ²
Area density	15 kg/m ²
Total width	170 mm
Effective width	140 mm
Standard length	3600 mm

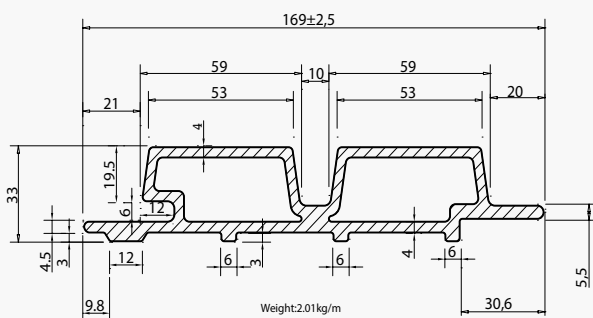

	WEO® 35	WEO® 60
Number of waves per board	3	2
Total wave length	46 mm	59 mm
False open-joint width	30 mm	53 mm
Depth of waves	20 mm	20 mm

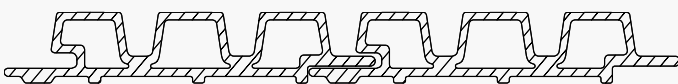

	No. of screws /m ²	No. of screws / 3.6 m board
Centre-to-centre distance 60 cm	16	7

1 - RANGE 09

2 - VERTICAL INSTALLATION ON ALL SUPPORTS 10

- Overview
- Foot of wall and parapet
- Window head and sill
- Metal reveal finish
- External corner
- Internal corner
- Horizontal joint
- Separation and air space cut-off
- Cladding end cover
- Vertical expansion joint
- Replacement of a board

3 - HORIZONTAL INSTALLATION ON ALL SUPPORTS 21

- Overview
- Foot of wall and parapet
- Window head and sill
- Metal reveal finish

- External corner
- Internal corner
- Vertical joint
- Separation and air space cut-off
- Cladding end cover
- Vertical expansion joint
- Replacement of a board

4 - PINSTALLATION ON WOODEN FRAMEWORK STRUCTURE 32

5 - INSTALLATION ON METAL FRAMEWORK 33

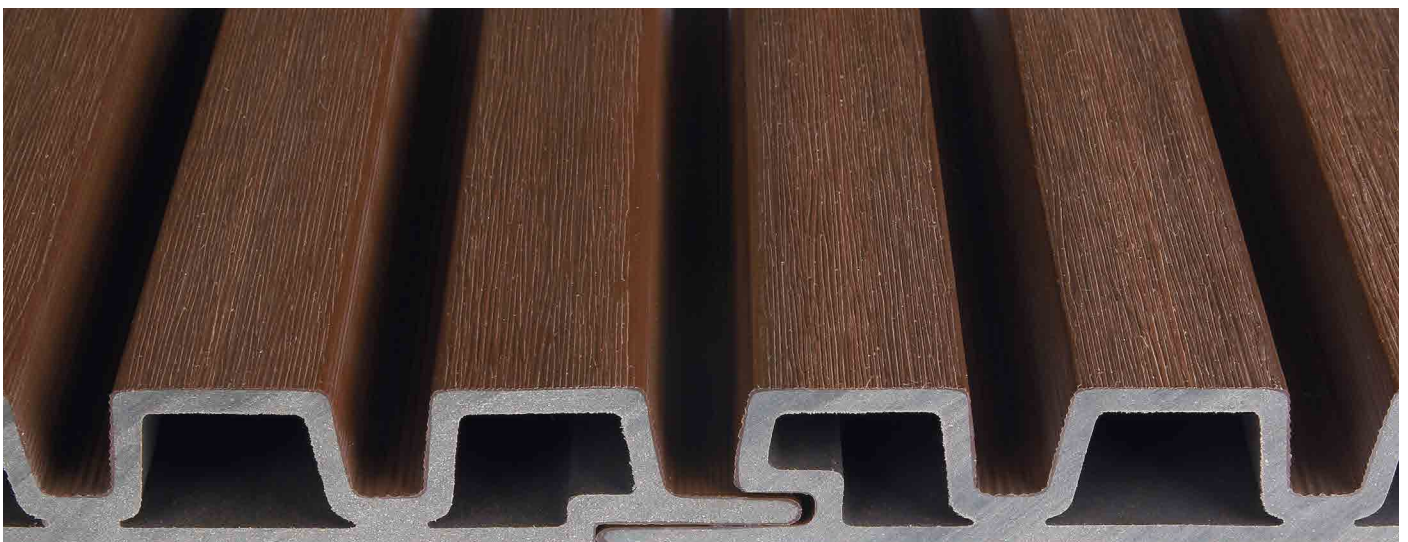

1- RANGE

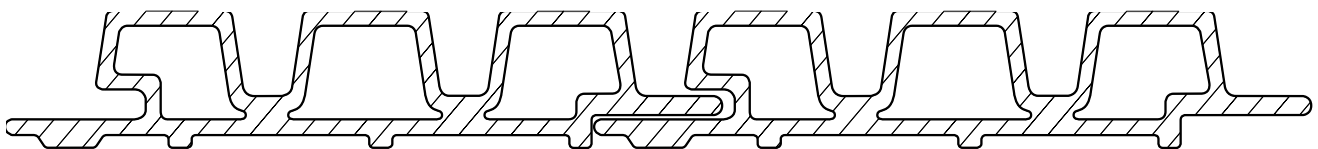
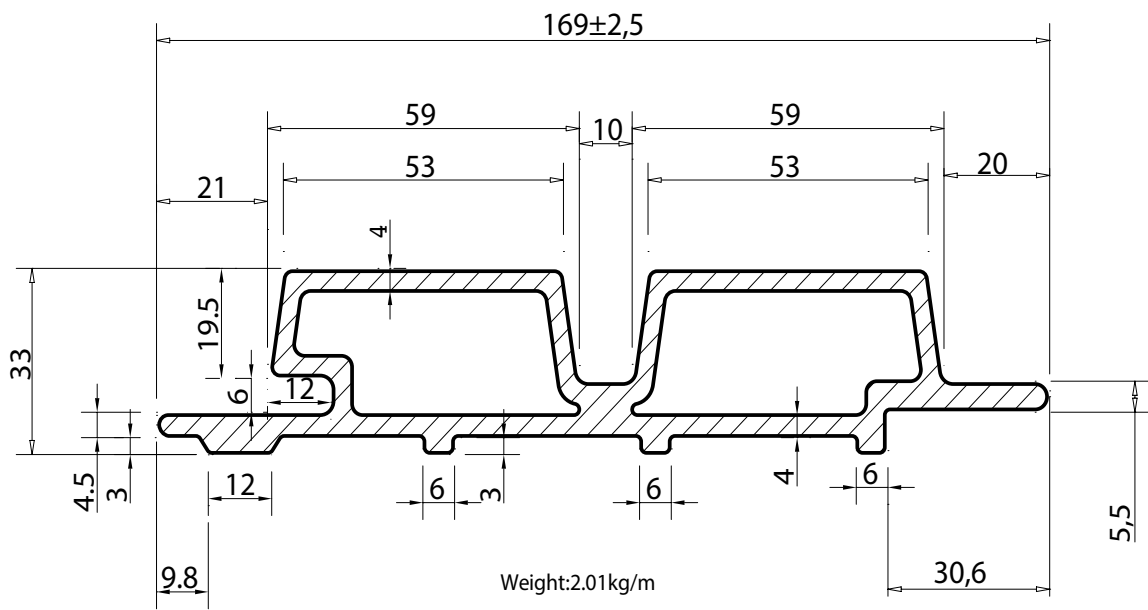
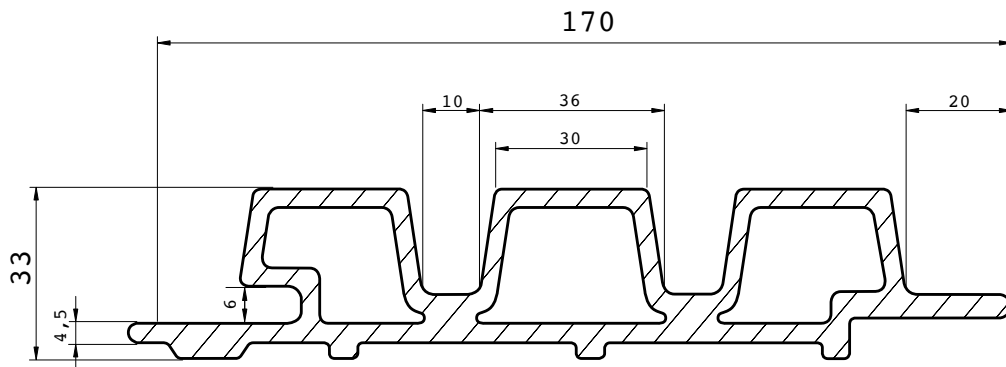



2 - VERTICAL INSTALLATION ON ALL SUPPORTS

2.1 - OVERVIEW



2 - VERTICAL INSTALLATION ON ALL SUPPORTS

2.2 - FOOT OF WALL AND PARAPET

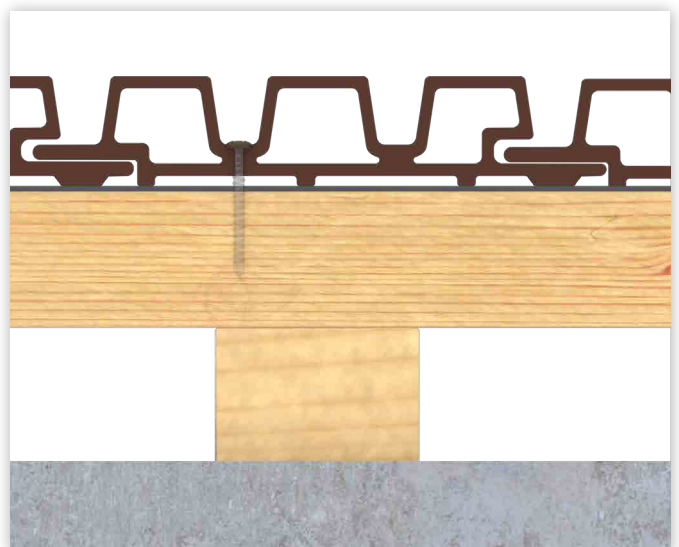
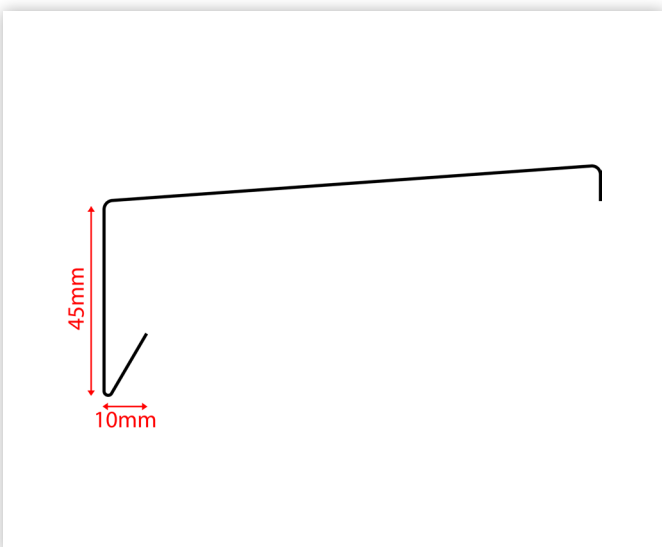
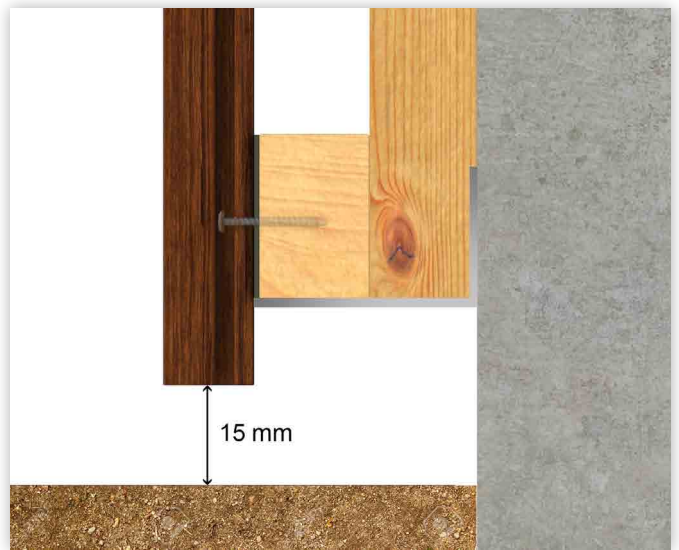
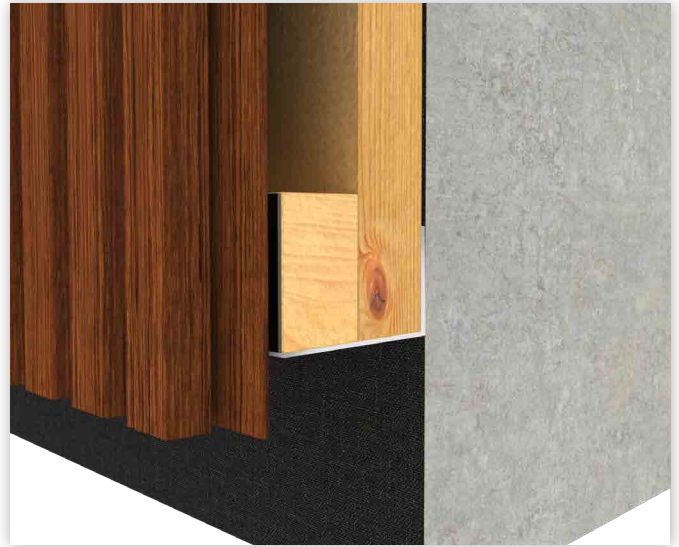
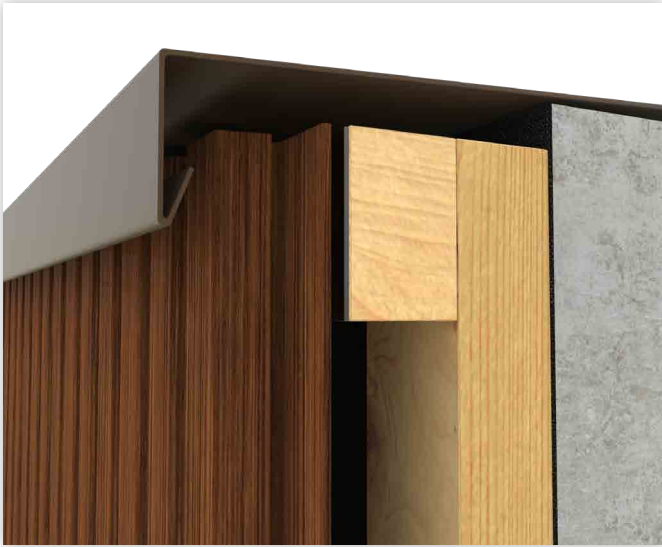

2 - VERTICAL INSTALLATION ON ALL SUPPORTS

2.3 - WINDOW HEAD AND SILL

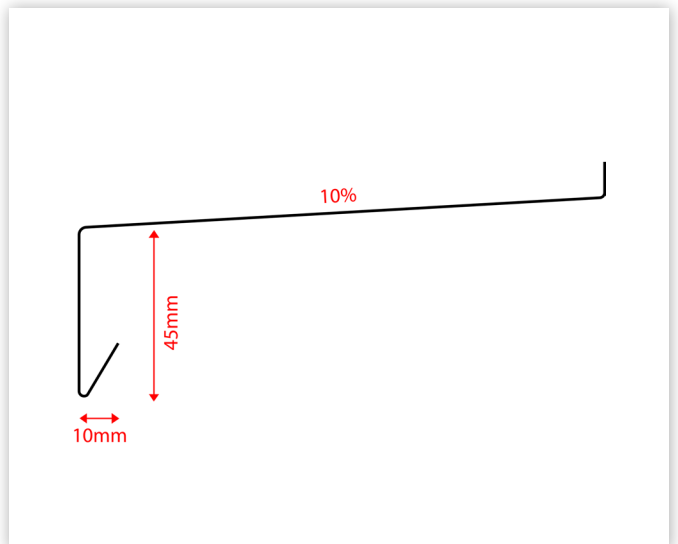
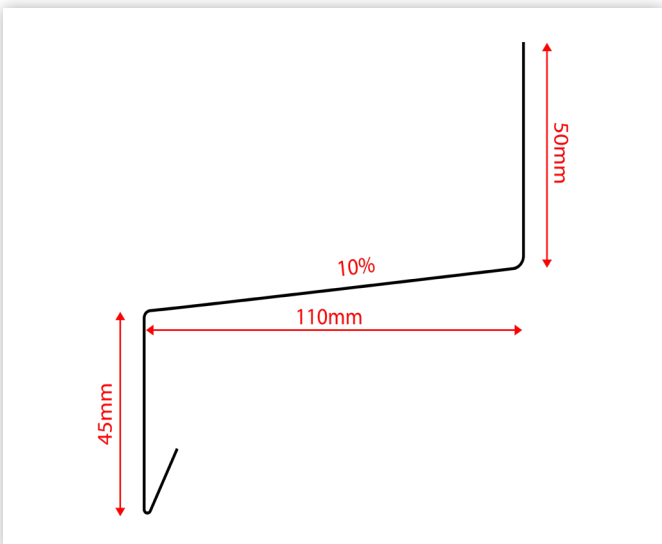
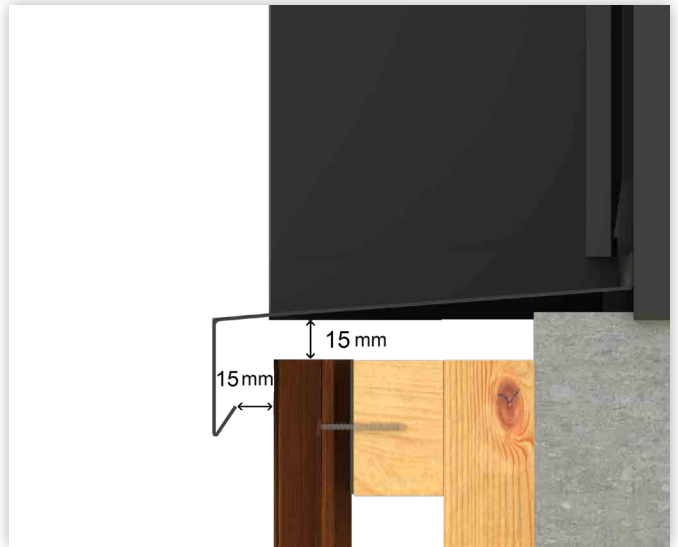
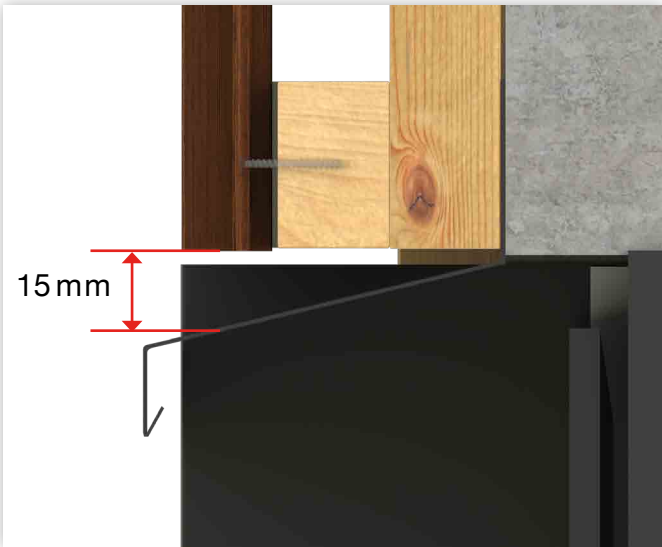

2 - VERTICAL INSTALLATION ON ALL SUPPORTS

2.4 - METAL REVEAL FINISH

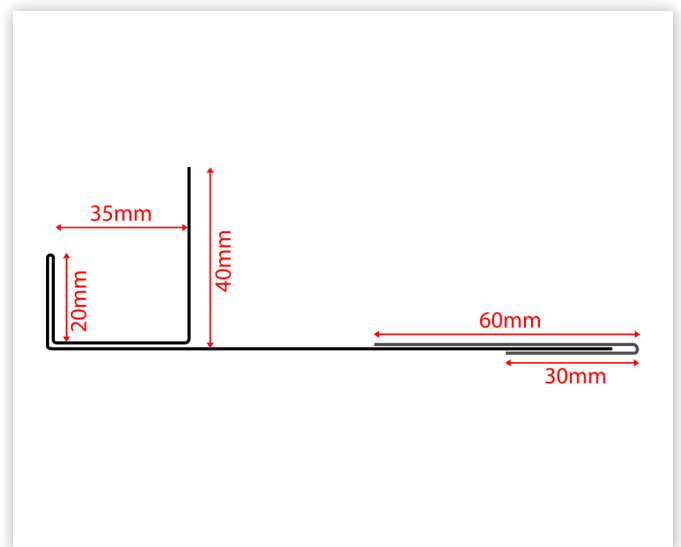
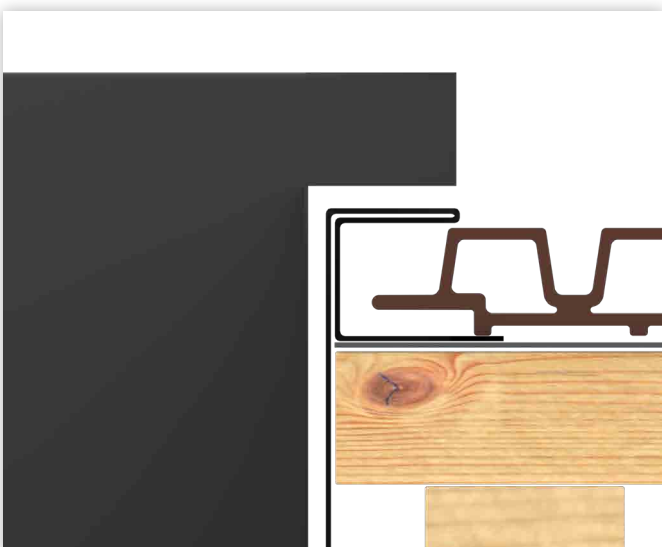
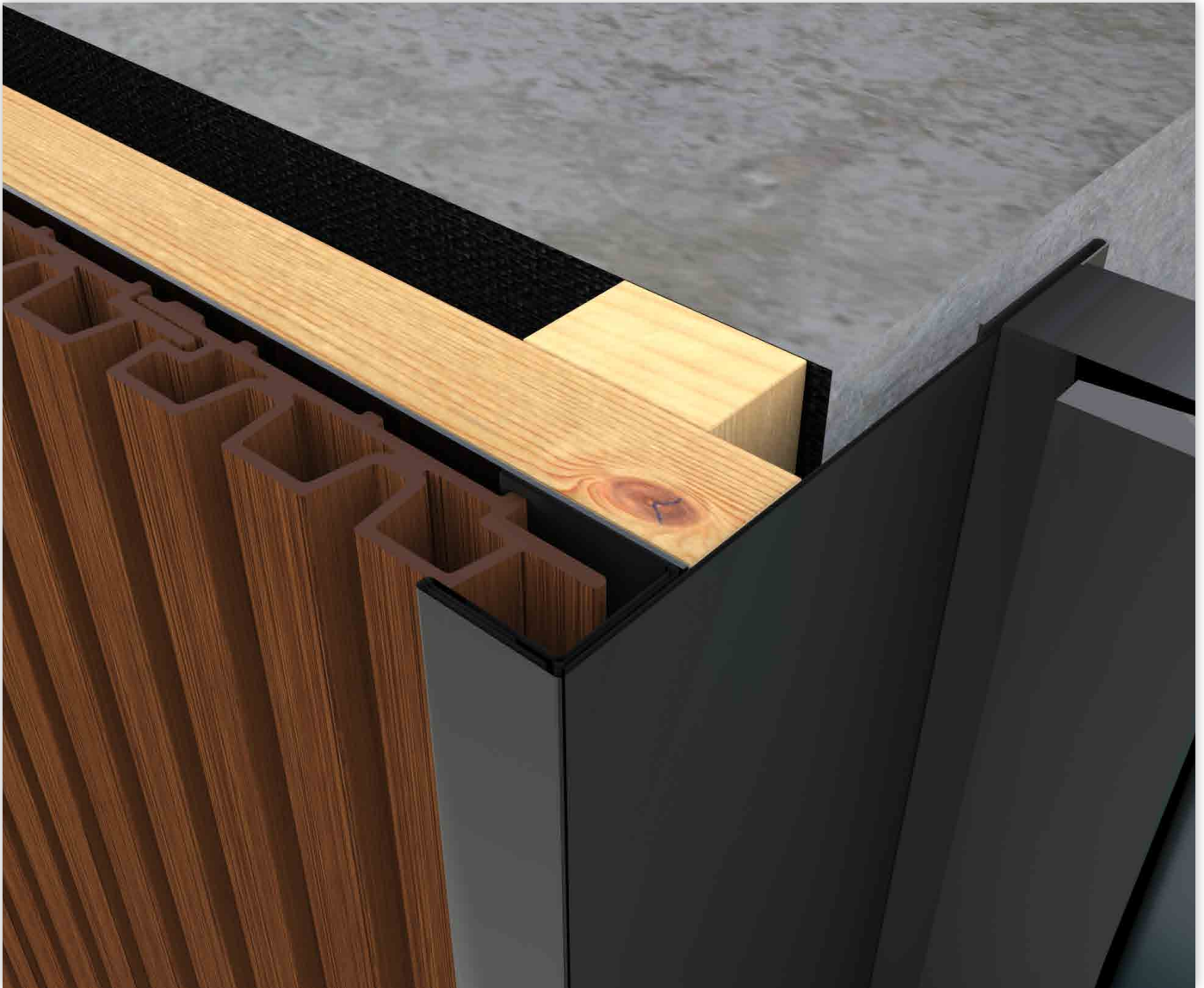

2 - VERTICAL INSTALLATION ON ALL SUPPORTS

2.5 - EXTERNAL CORNER

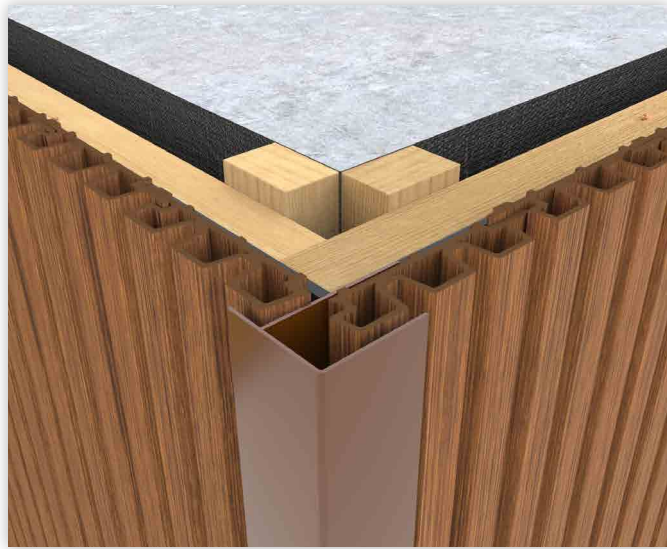

2.5.1 - INTERNAL CORNER

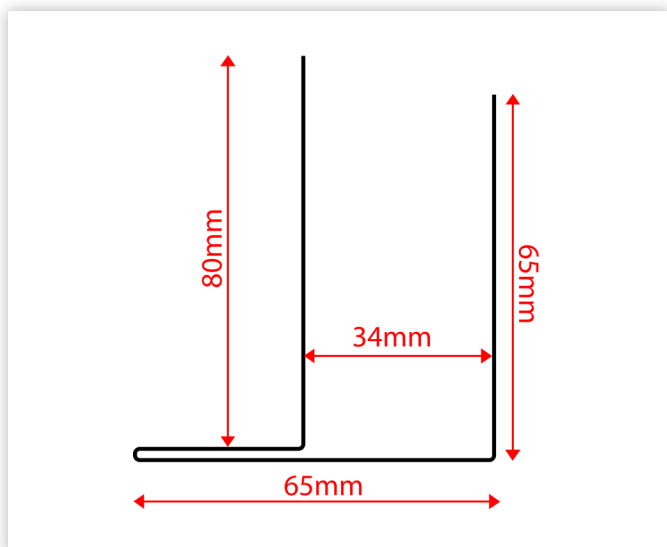
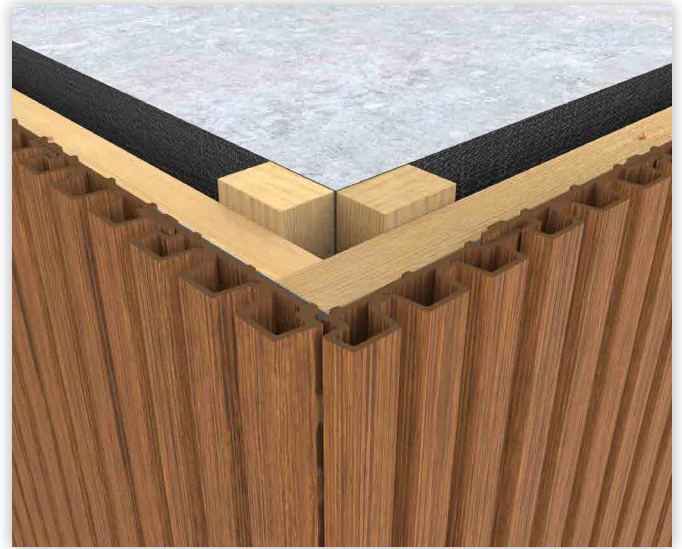

2 - VERTICAL INSTALLATION ON ALL SUPPORTS

2.6 - INTERNAL CORNER

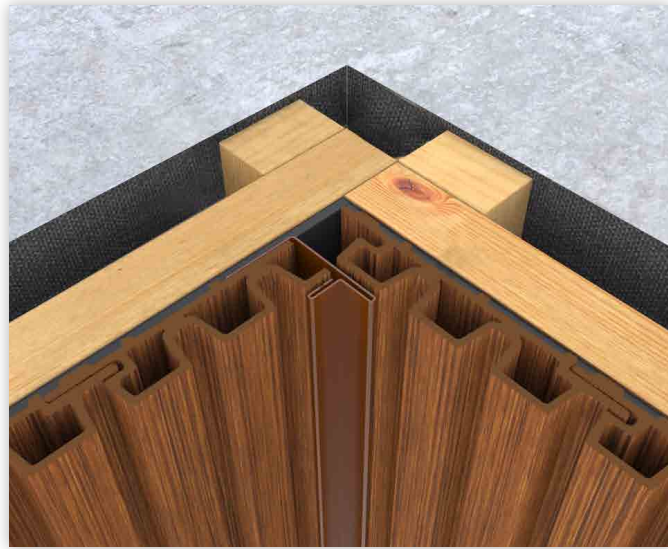

2.6.1 - EXTERNAL CORNER

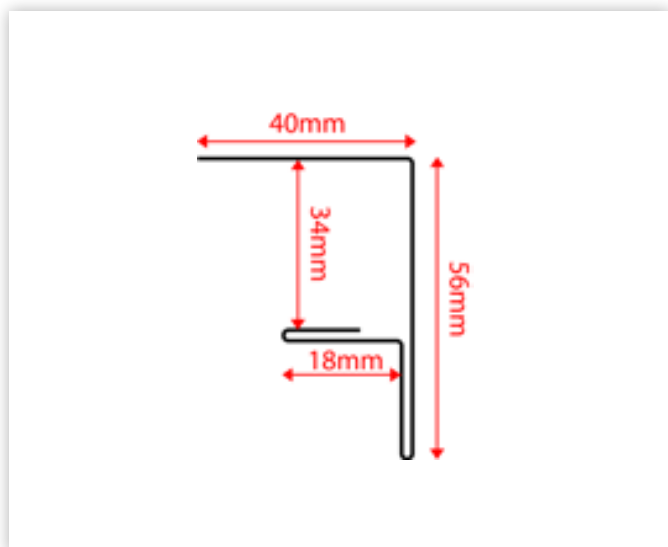
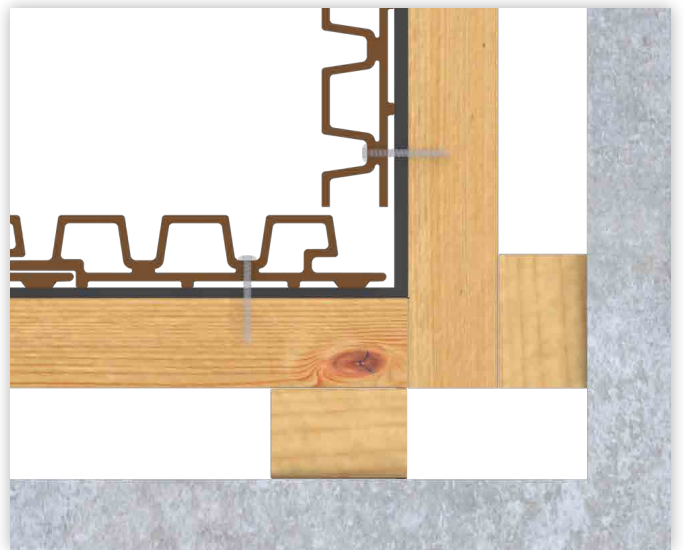
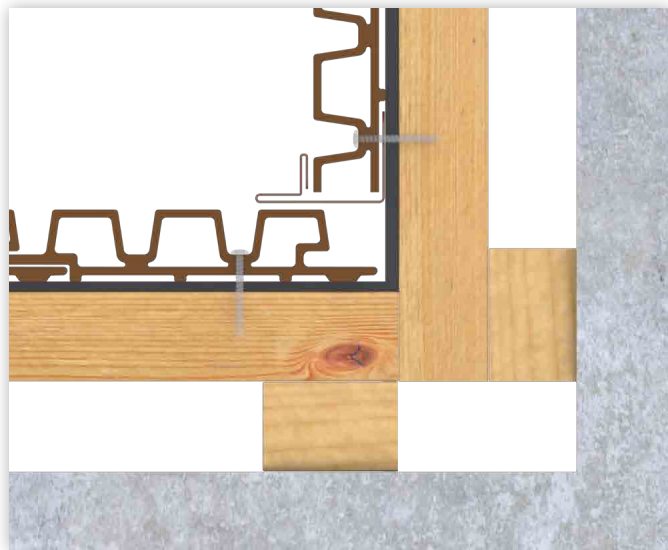
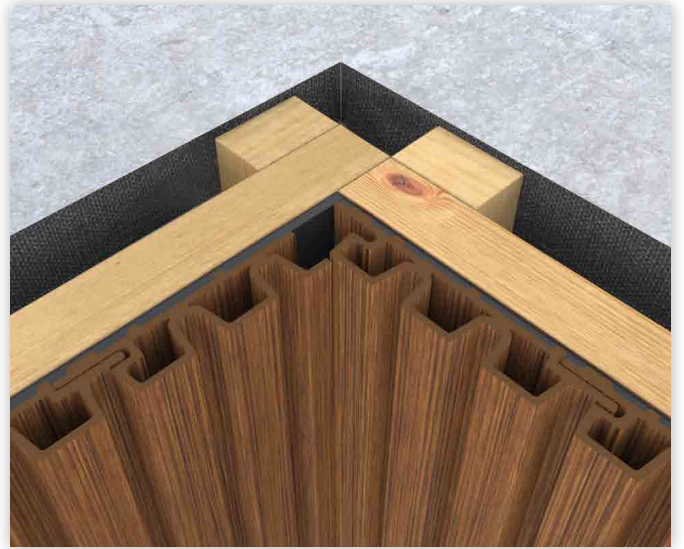



2 - VERTICAL INSTALLATION ON ALL SUPPORTS

2.7 - HORIZONTAL JOINT

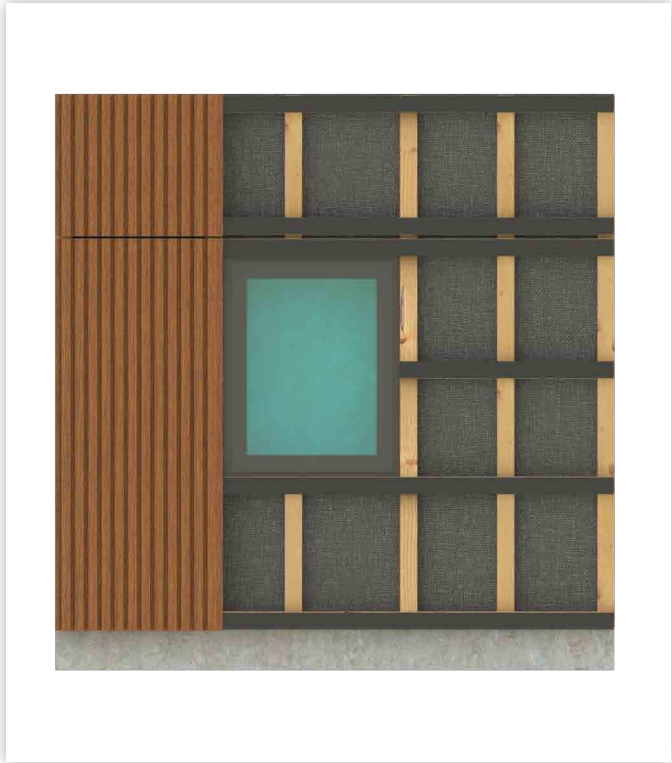

2 - VERTICAL INSTALLATION ON ALL SUPPORTS

2.8 - SEPARATION AND AIR SPACE CUT-OFF

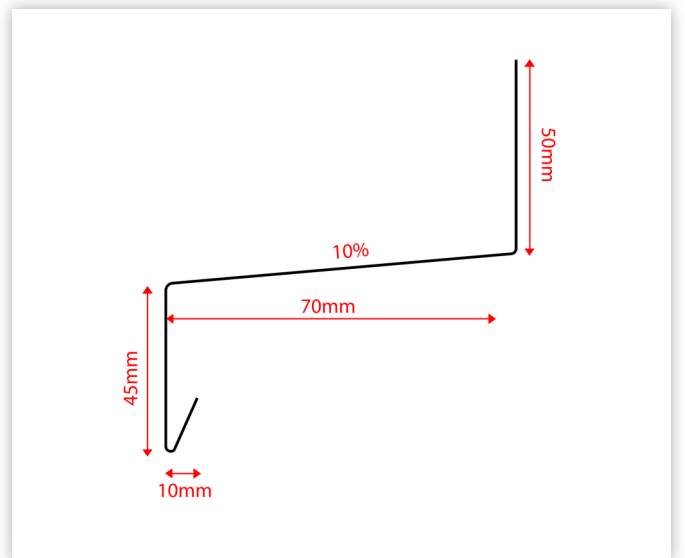
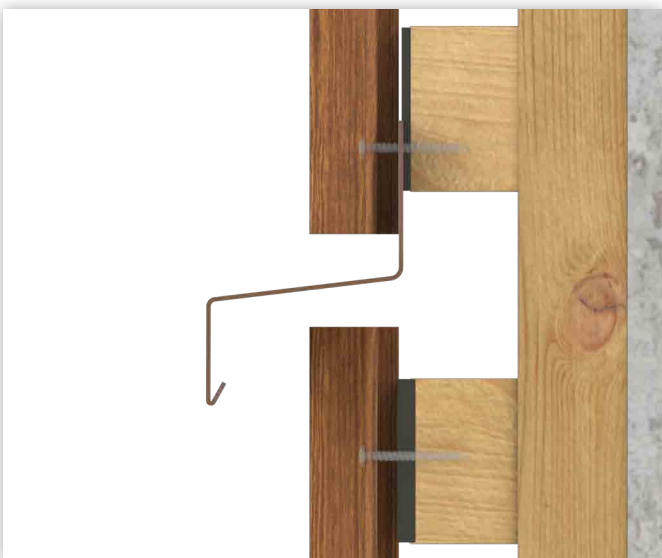

2 - VERTICAL INSTALLATION ON ALL SUPPORTS

2.9 - CLADDING END COVER

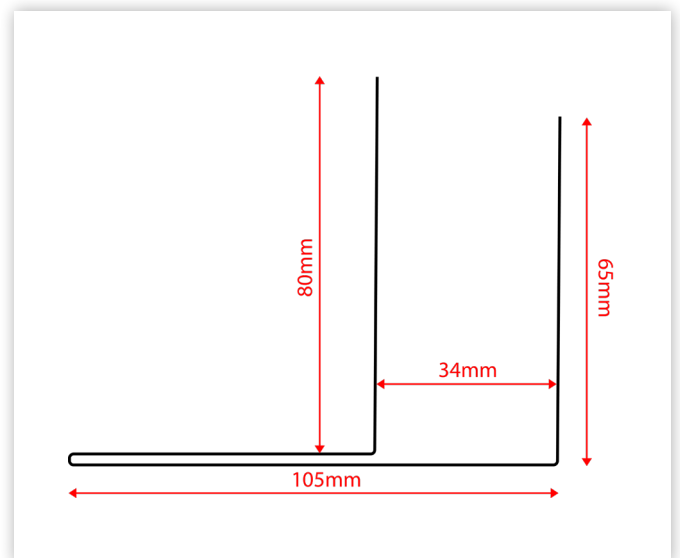
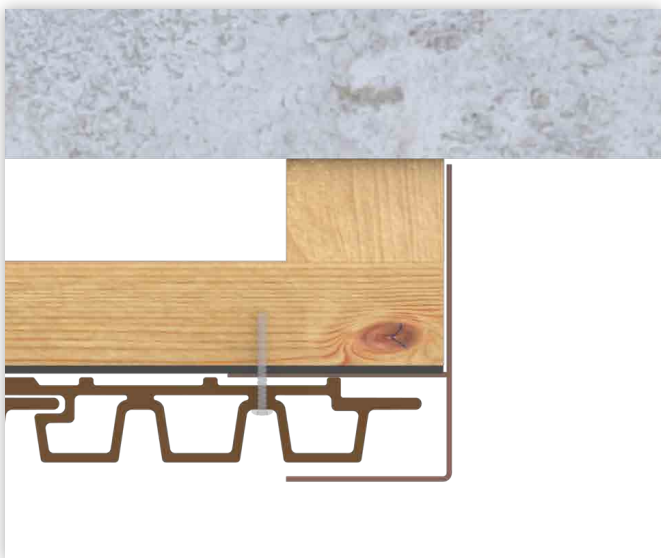
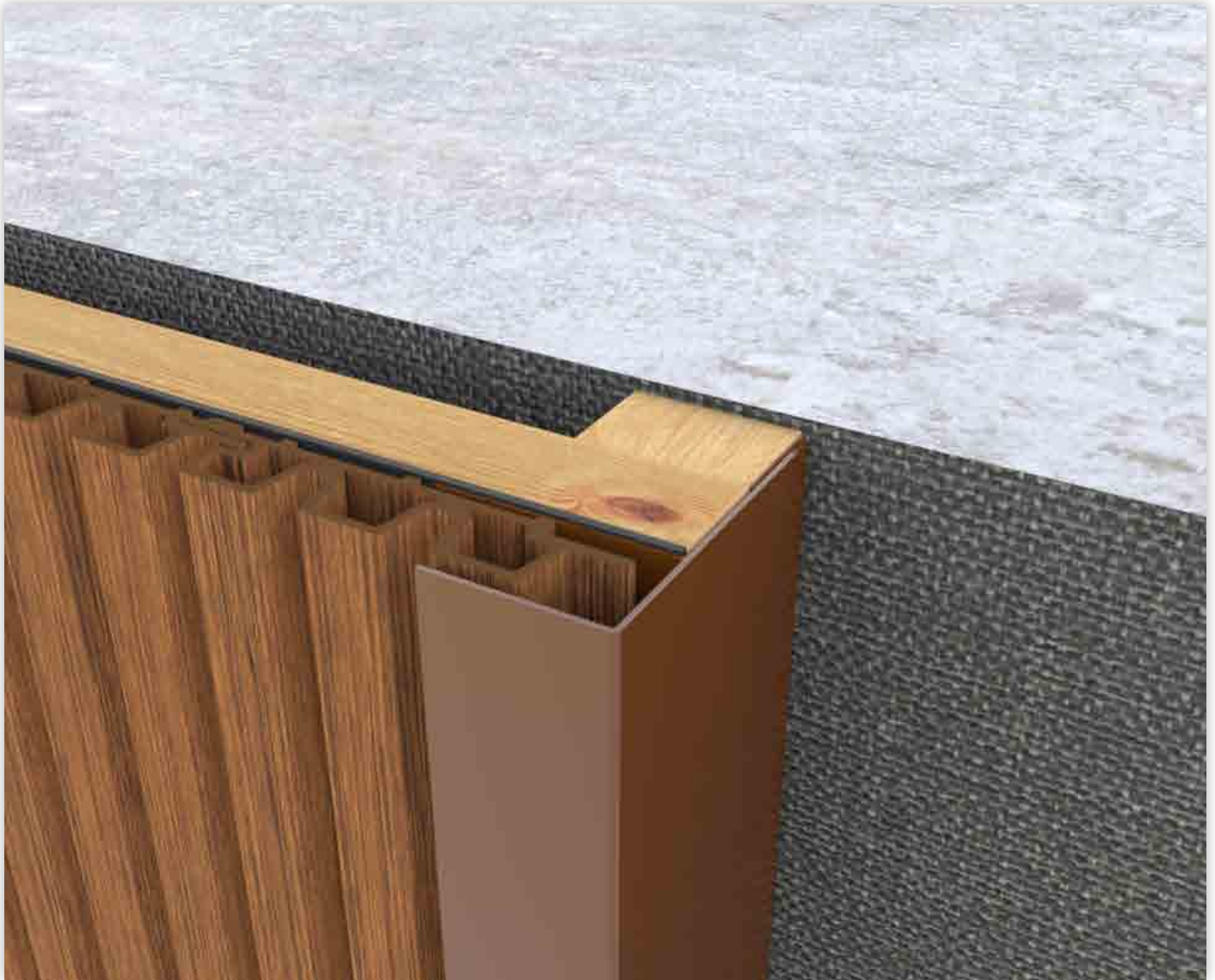

2 - VERTICAL INSTALLATION ON ALL SUPPORTS

2.10 - VERTICAL EXPANSION JOINT

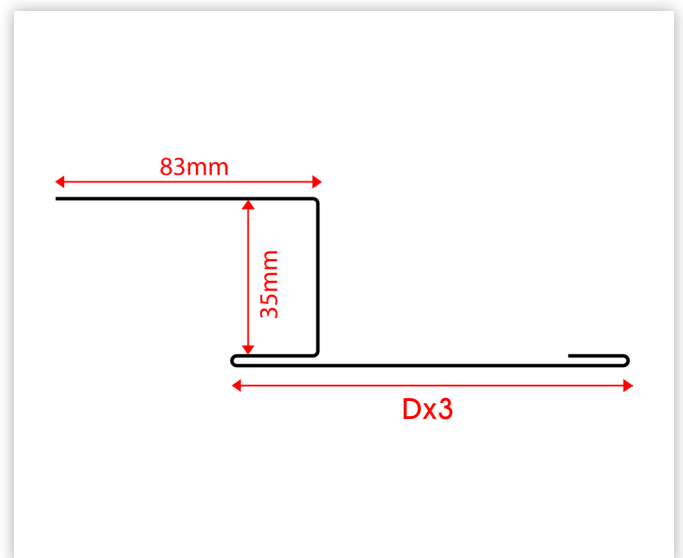
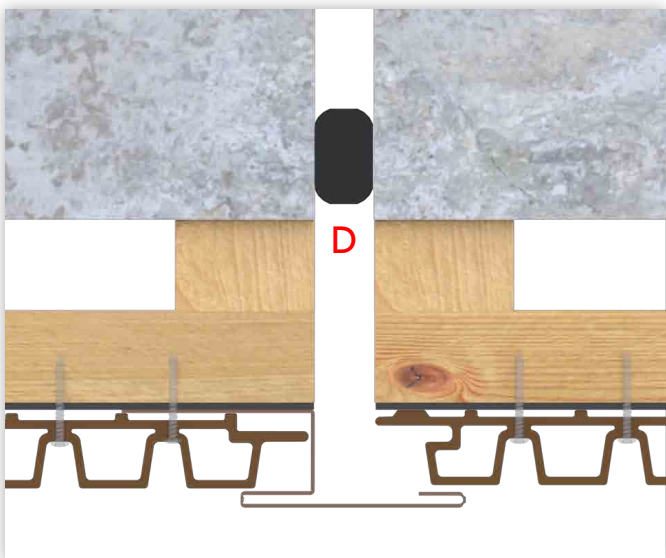
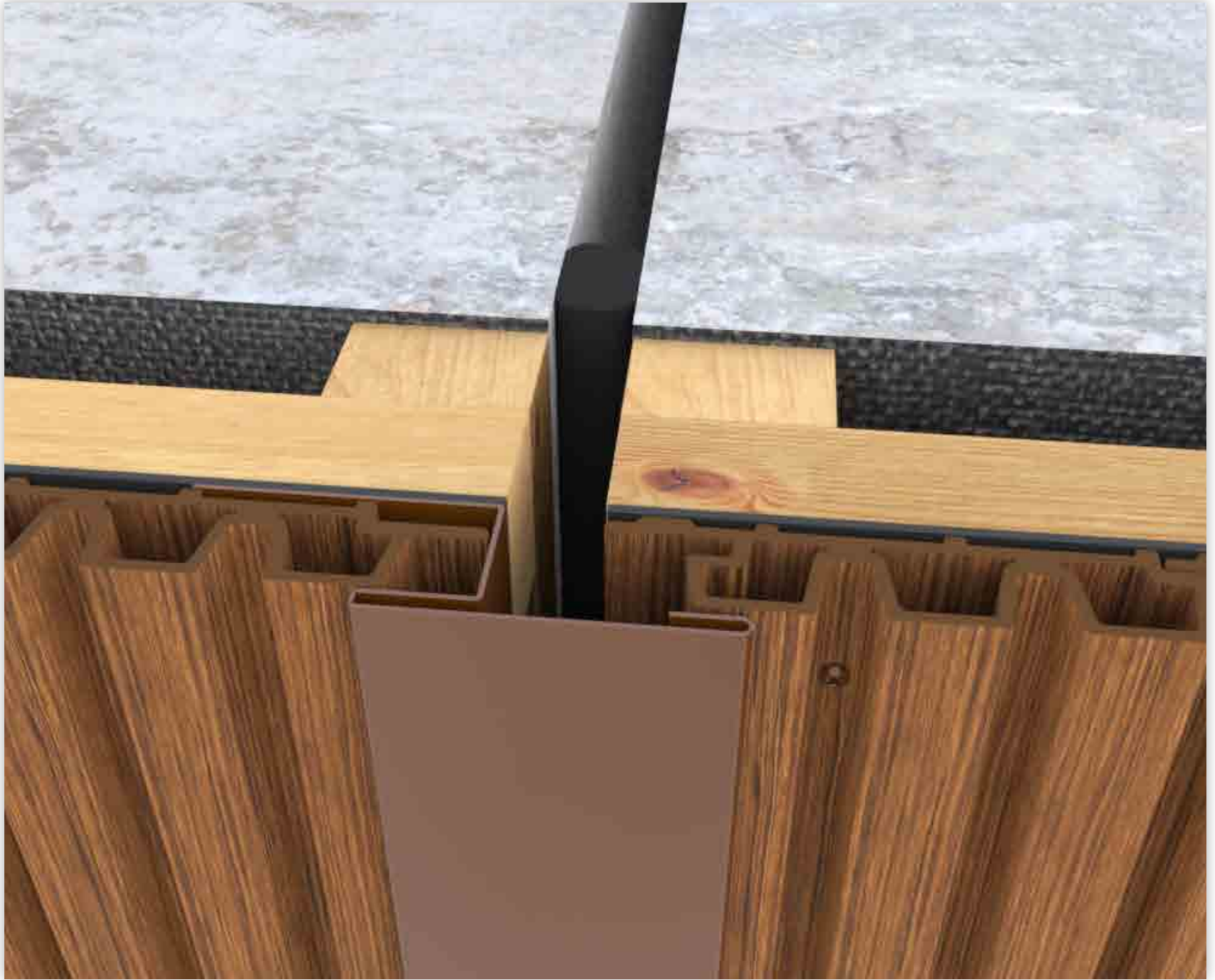

2 - VERTICAL INSTALLATION ON ALL SUPPORTS

2.11 - REPLACEMENT OF A BOARD

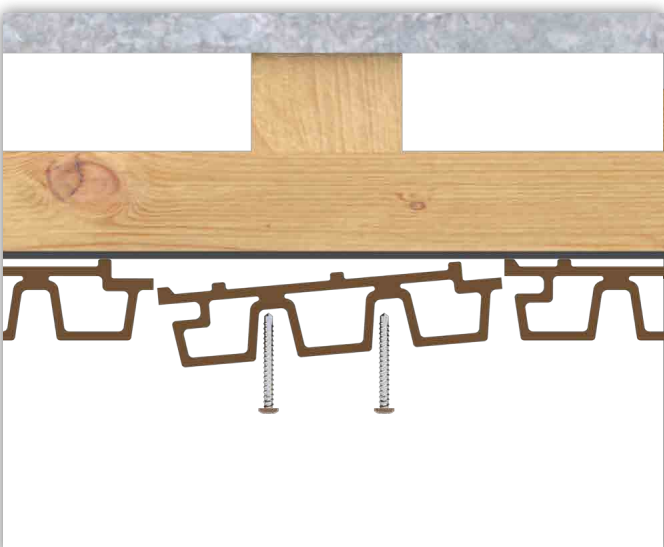
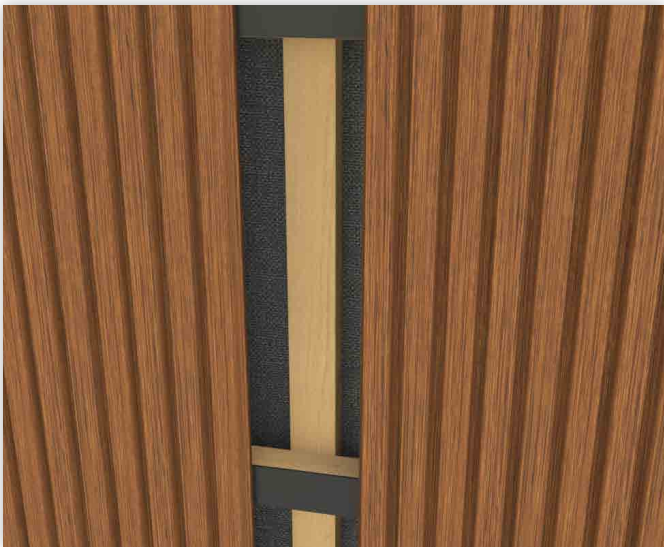

3 - HORIZONTAL INSTALLATION ON ALL SUPPORTS

3.2 - FOOT OF WALL AND PARAPET

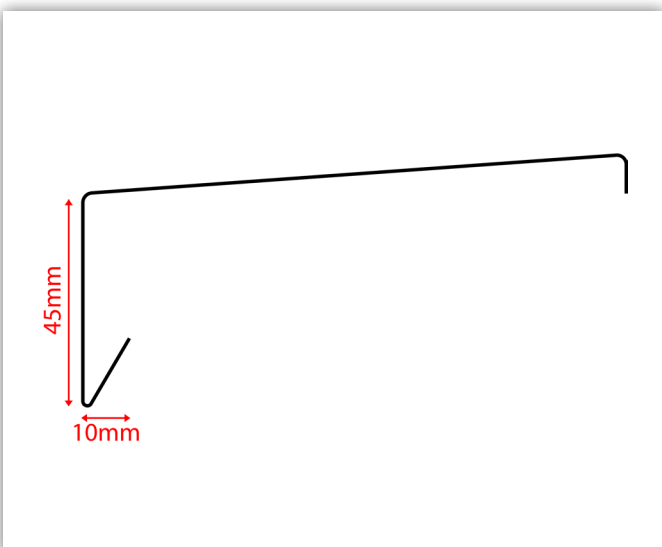
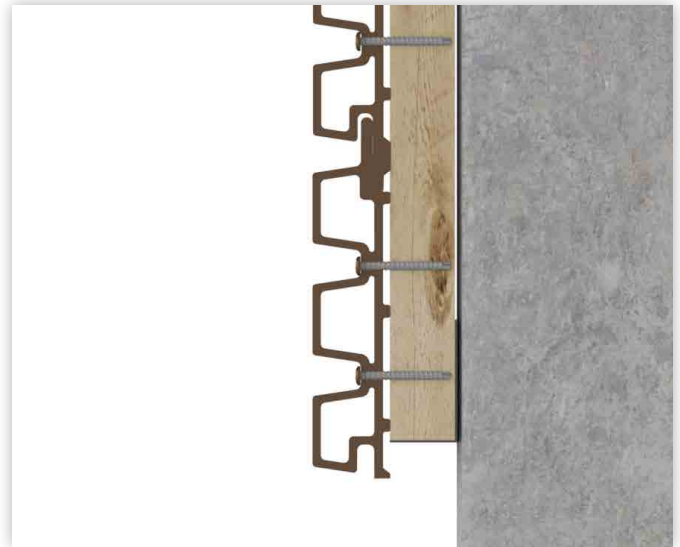
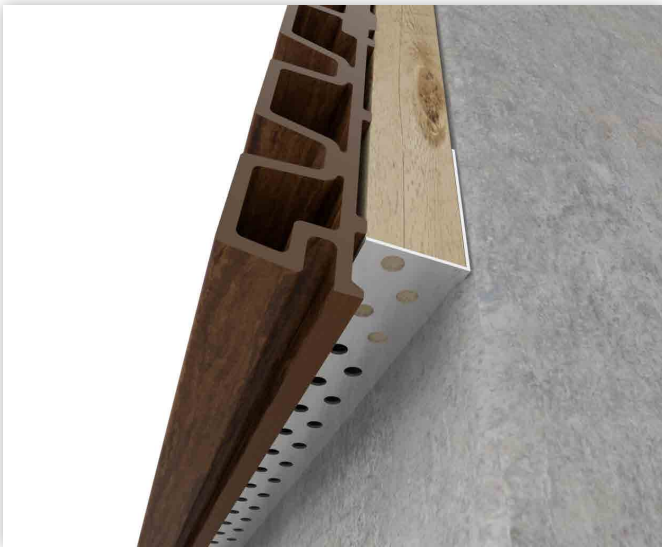
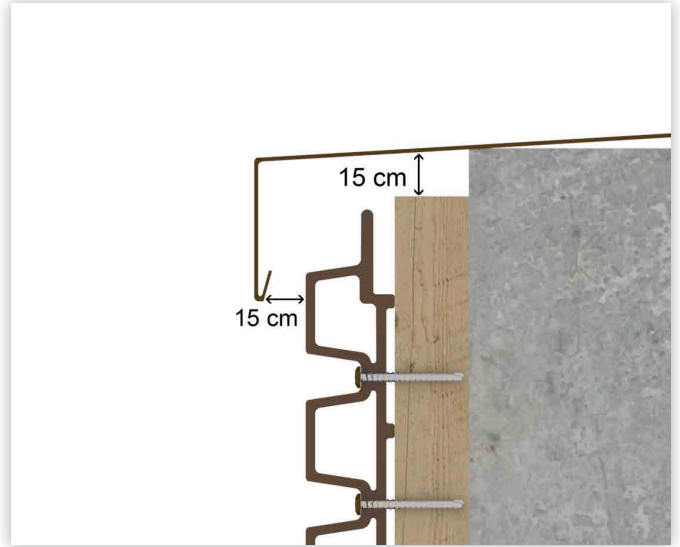

3 - HORIZONTAL INSTALLATION ON ALL SUPPORTS

3.3 - WINDOW HEAD AND SILL

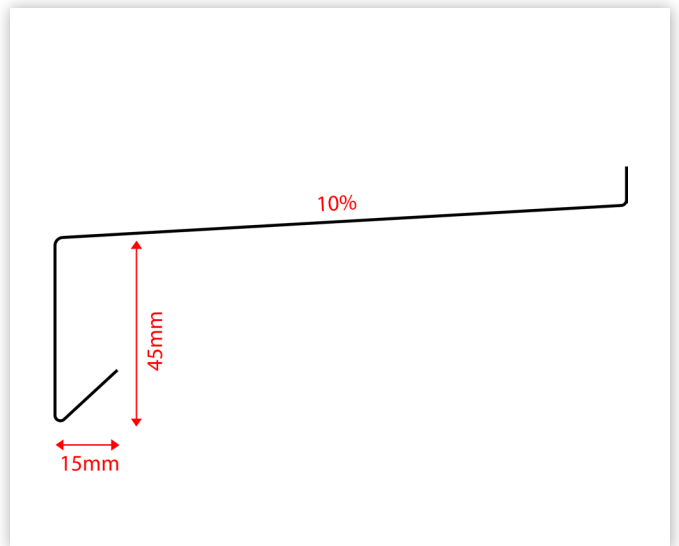
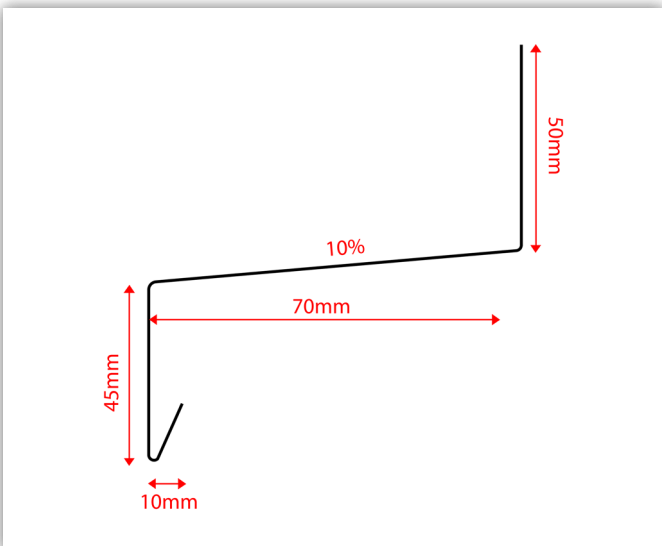
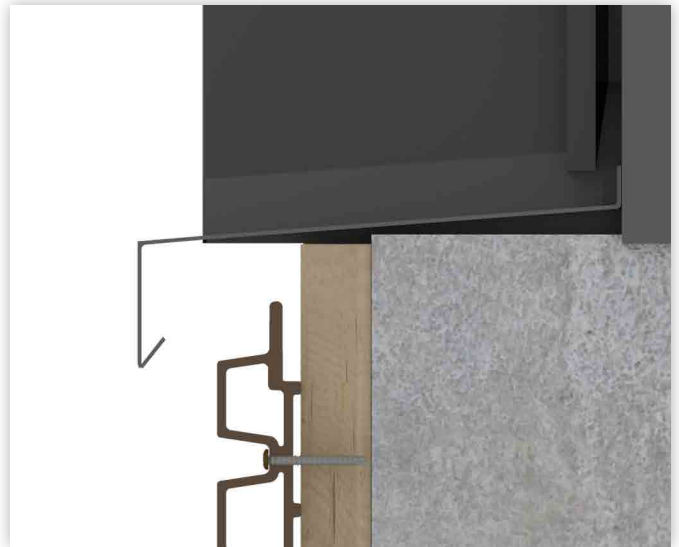
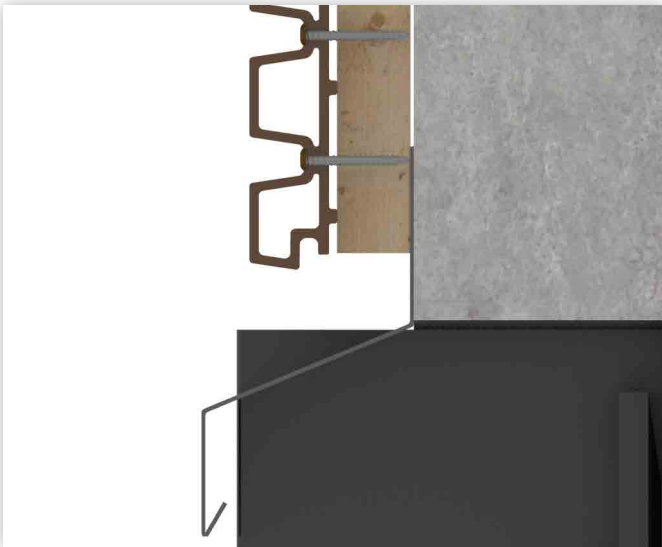

3 - HORIZONTAL INSTALLATION ON ALL SUPPORTS

3.4 - METAL REVEAL FINISH

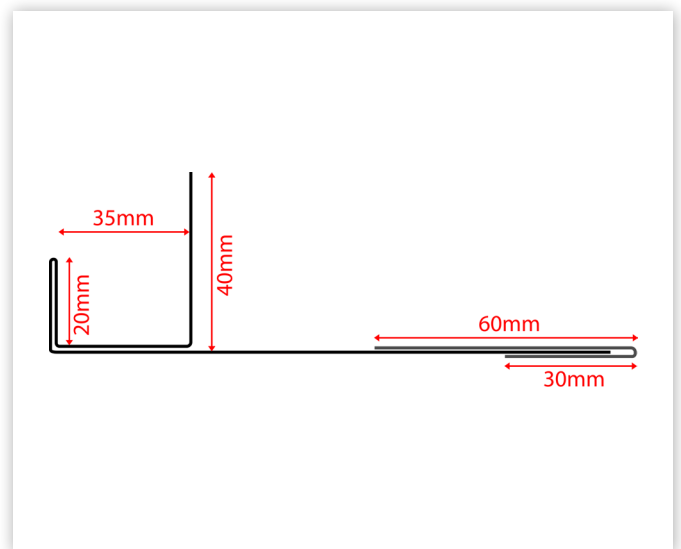
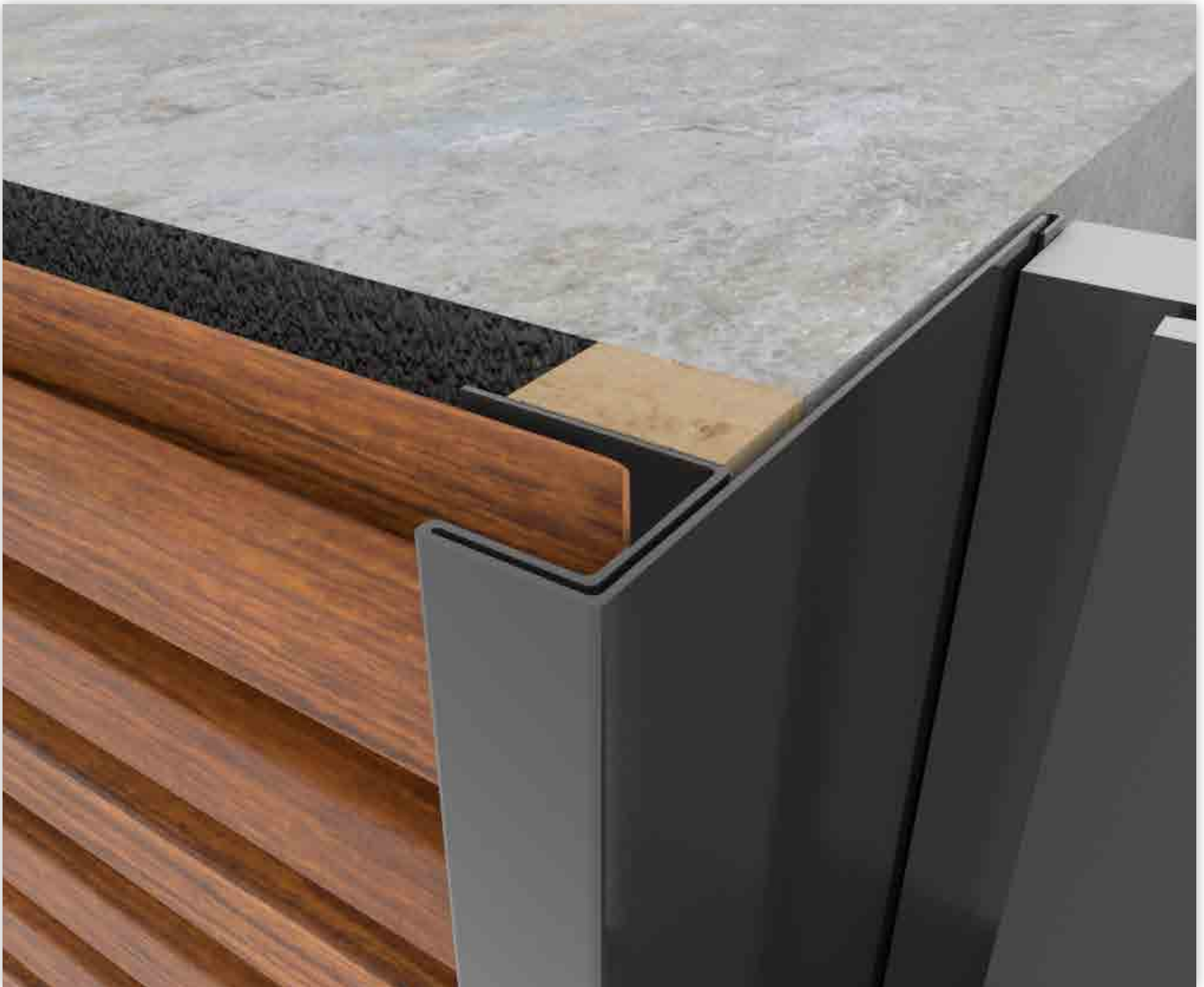

3 - HORIZONTAL INSTALLATION ON ALL SUPPORTS

3.5 - EXTERNAL CORNER

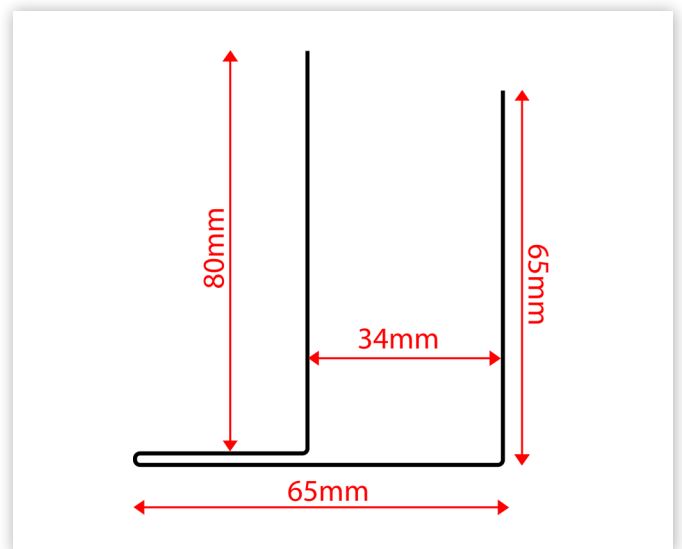
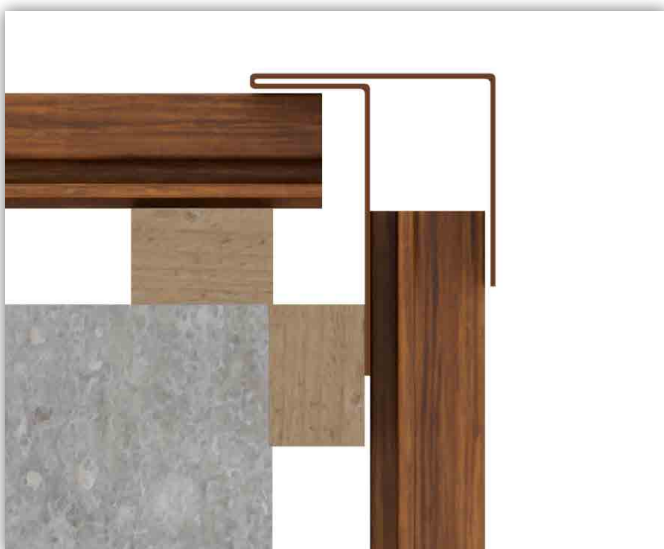

3 - HORIZONTAL INSTALLATION ON ALL SUPPORTS

3.6 - INTERNAL CORNER

3.6.1 - INTERNAL CORNER

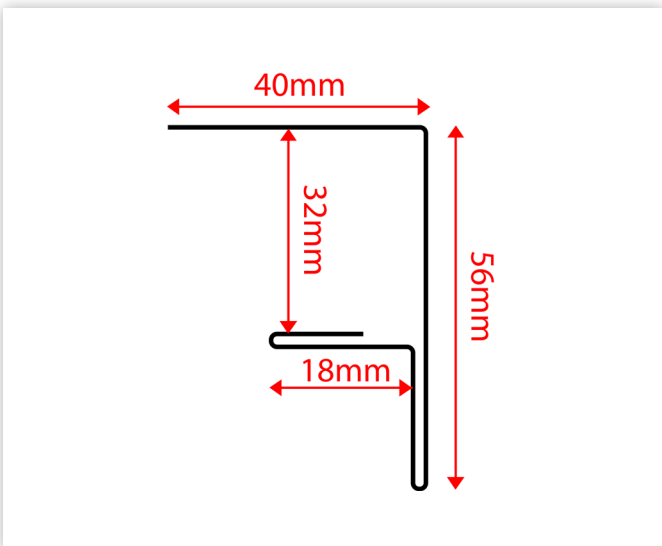
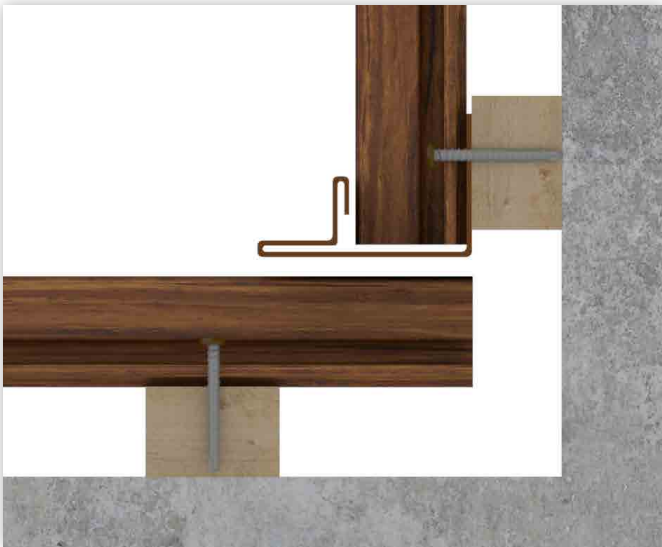
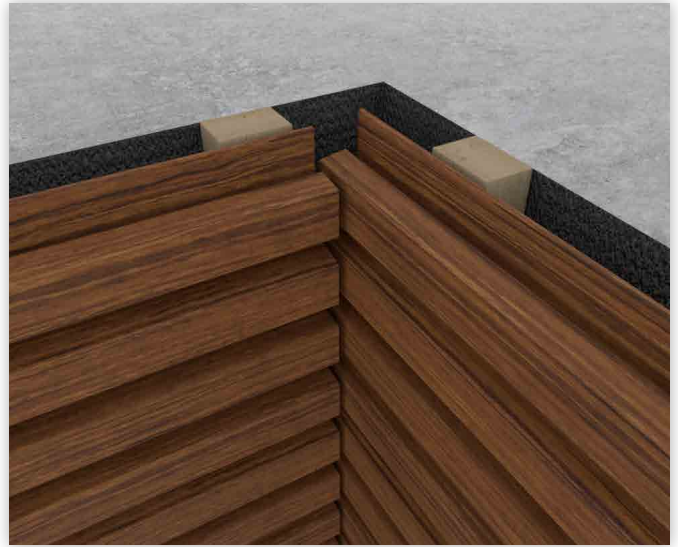
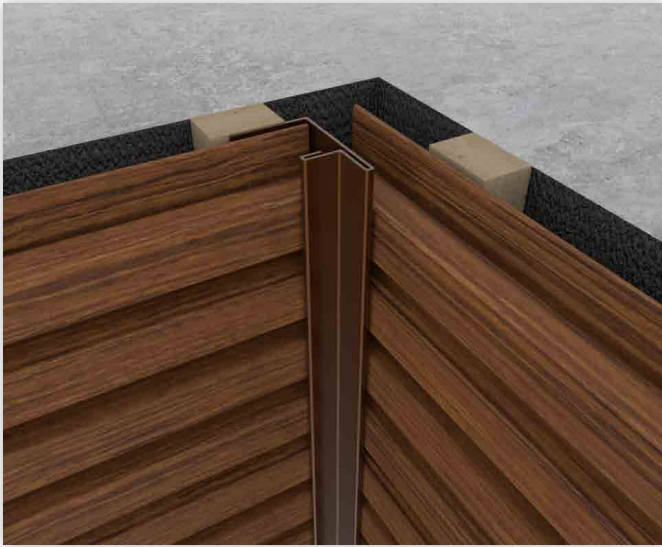

3 - HORIZONTAL INSTALLATION ON ALL SUPPORTS

3.7 - VERTICAL JOINT

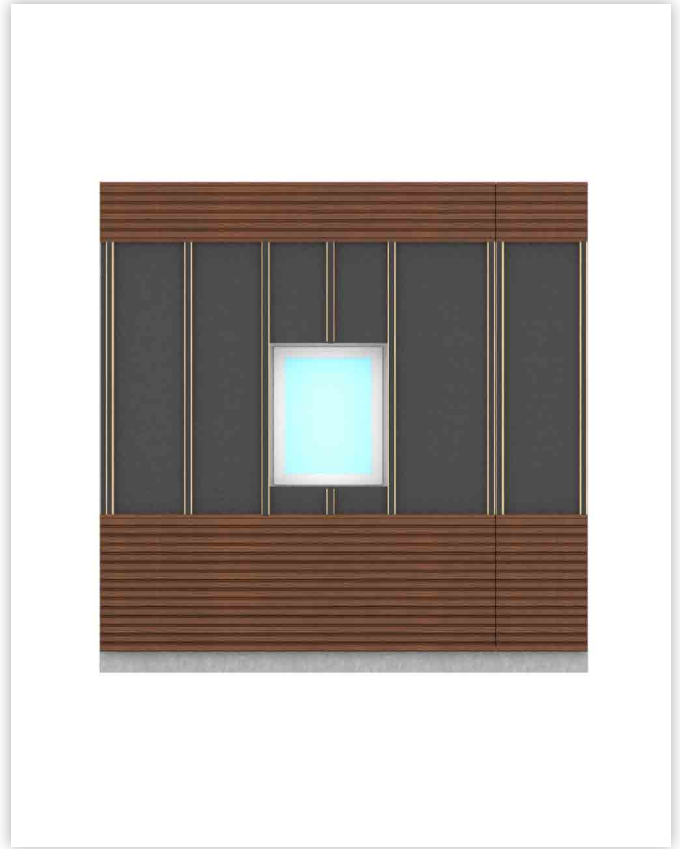
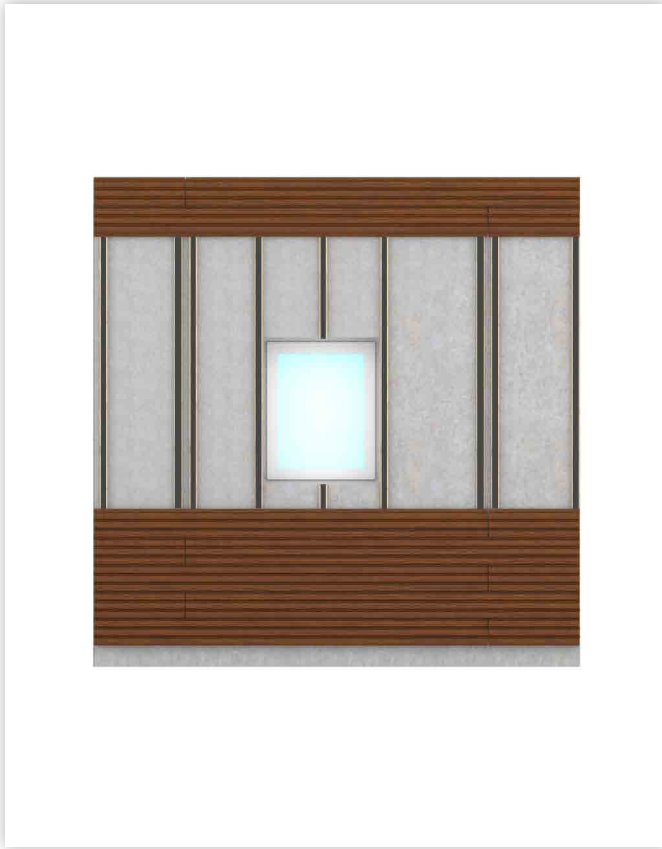

3 - HORIZONTAL INSTALLATION ON ALL SUPPORTS

3.8 - SEPARATION AND AIR SPACE CUT-OFF

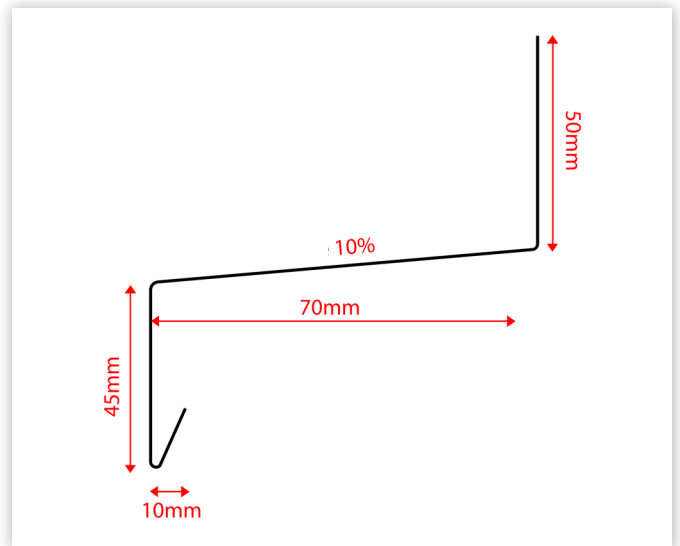
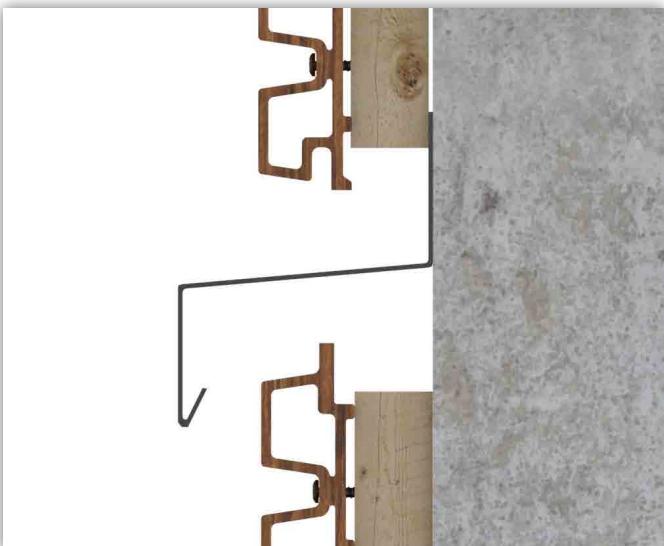

3 - HORIZONTAL INSTALLATION ON ALL SUPPORTS

3.9 - CLADDING END COVER

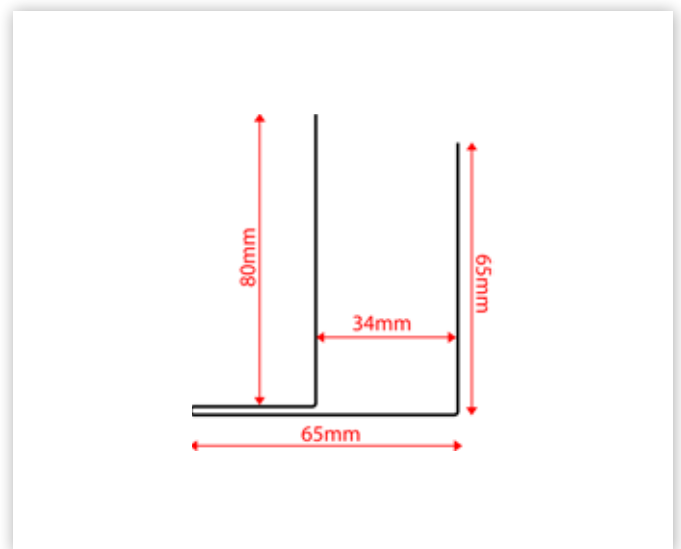
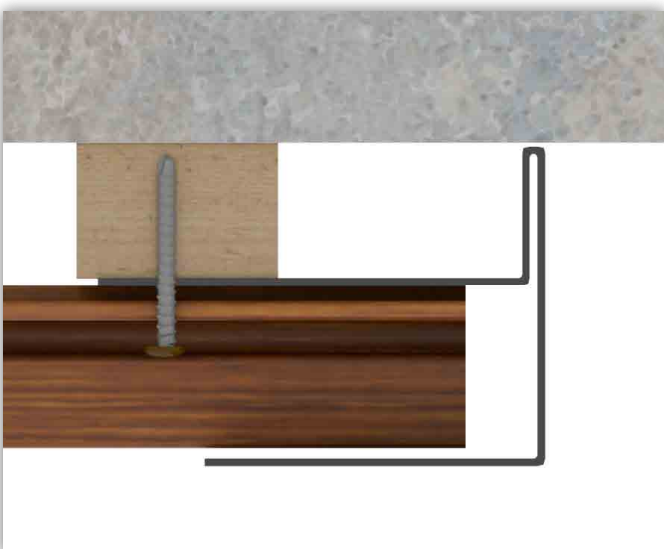
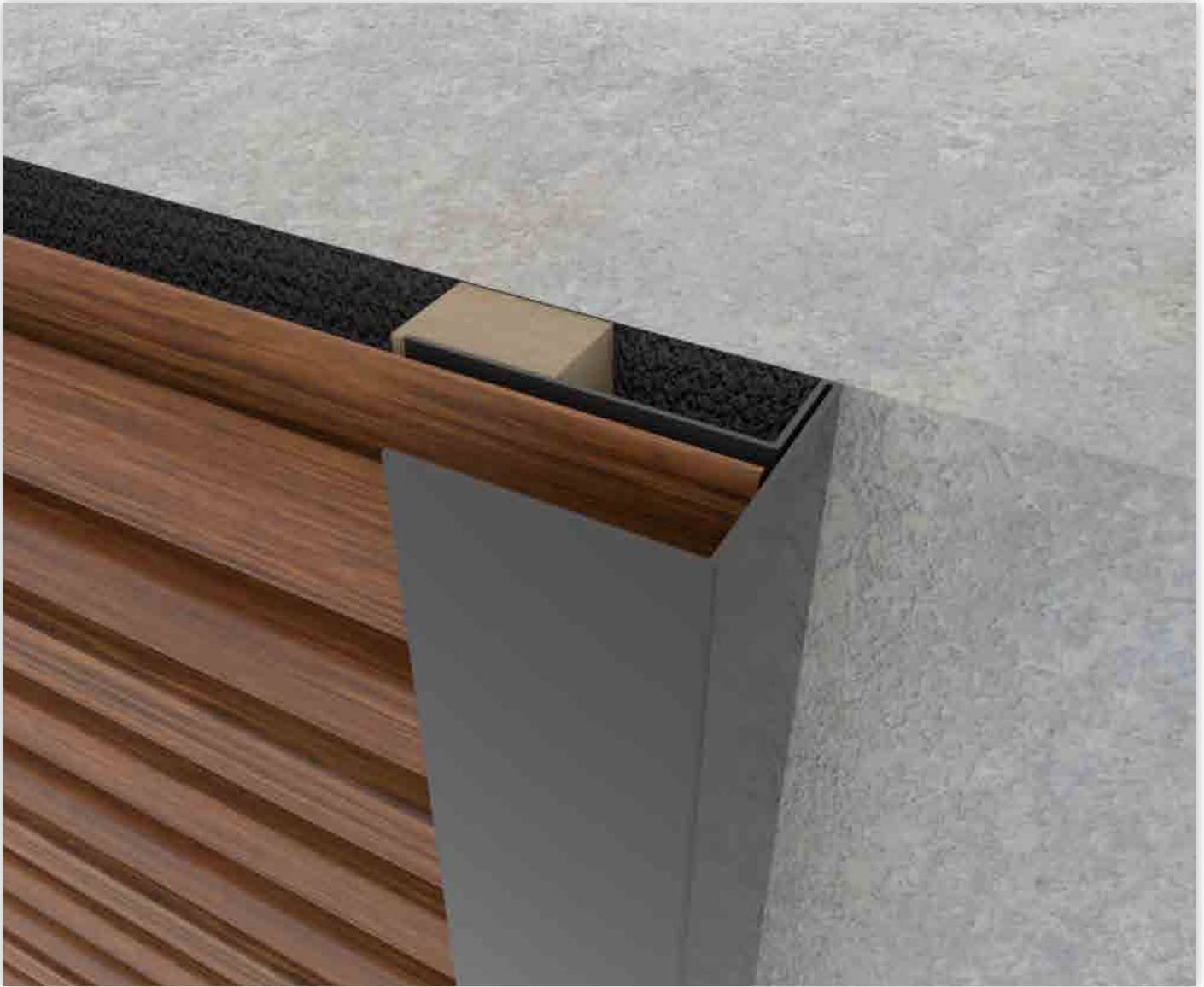

3 - HORIZONTAL INSTALLATION ON ALL SUPPORTS

3.10 - VERTICAL EXPANSION JOINT

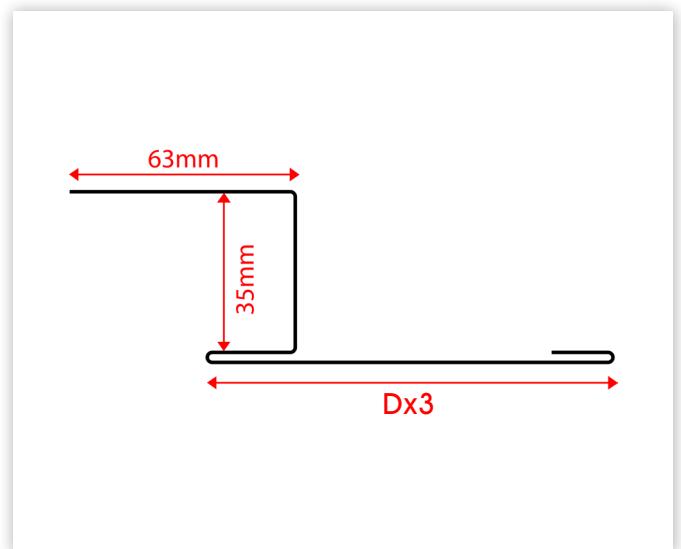
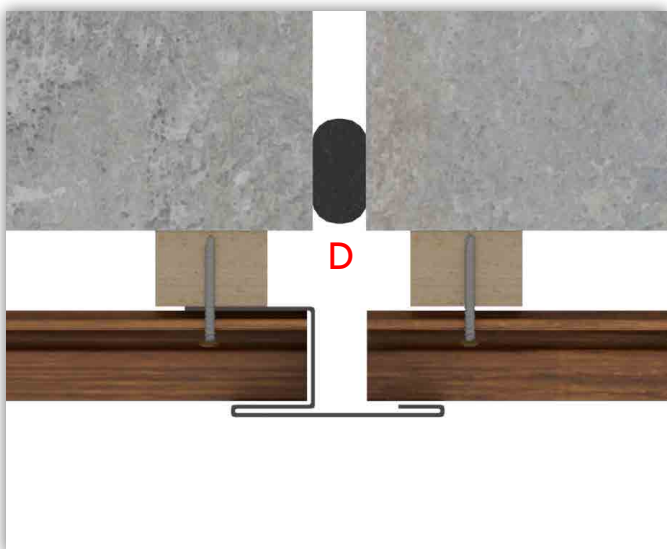
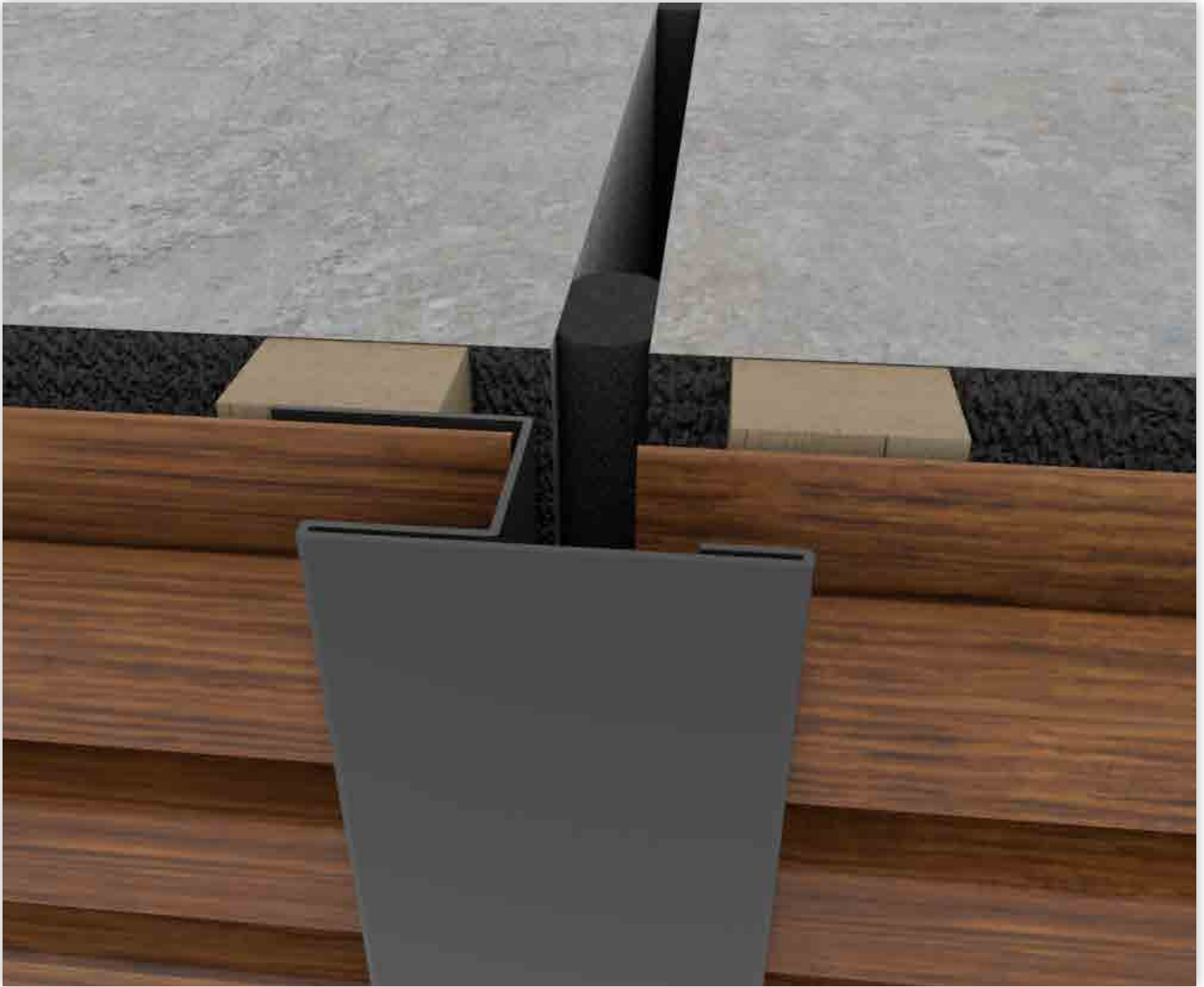

3 - HORIZONTAL INSTALLATION ON ALL SUPPORTS

3.11 - REPLACEMENT OF A BOARD

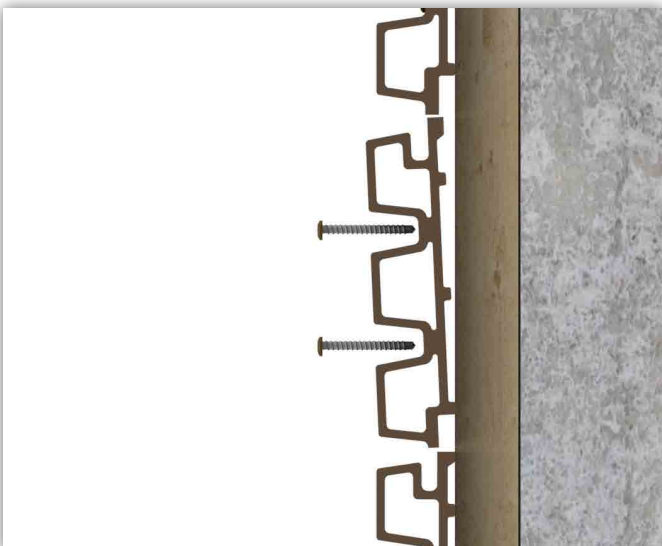
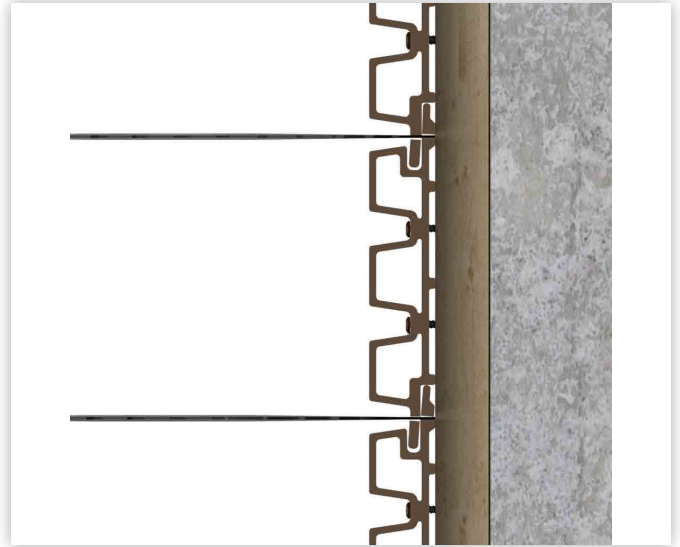
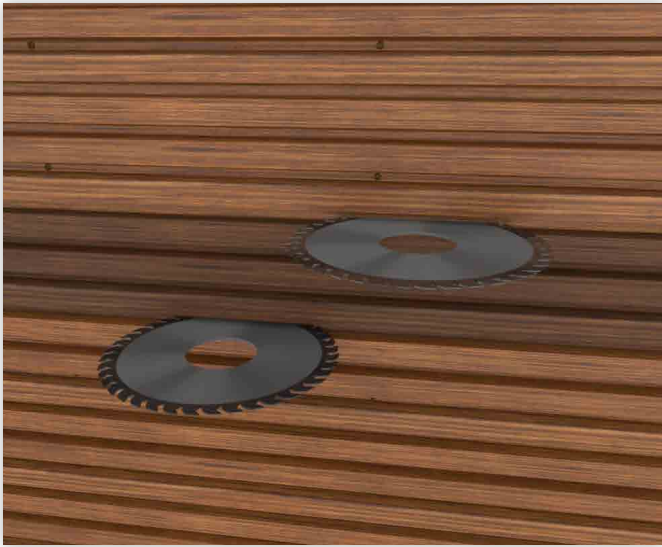

4 - PINSTALLATION ON WOODEN FRAMEWORK STRUCTURE

4.1 - HORIZONTAL INSTALLATION

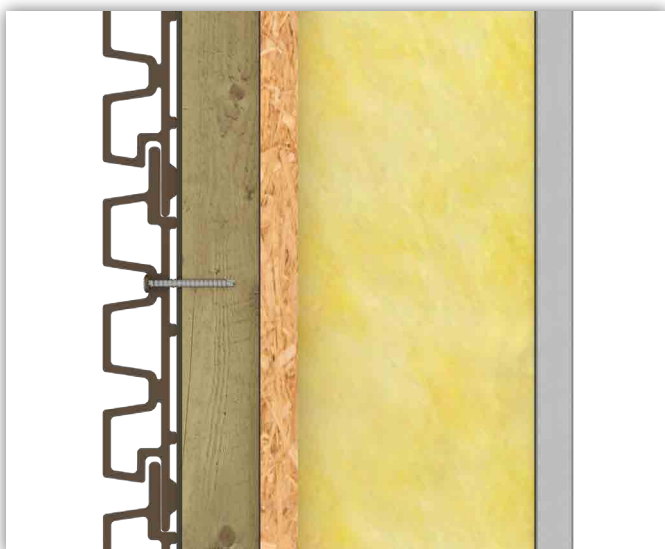
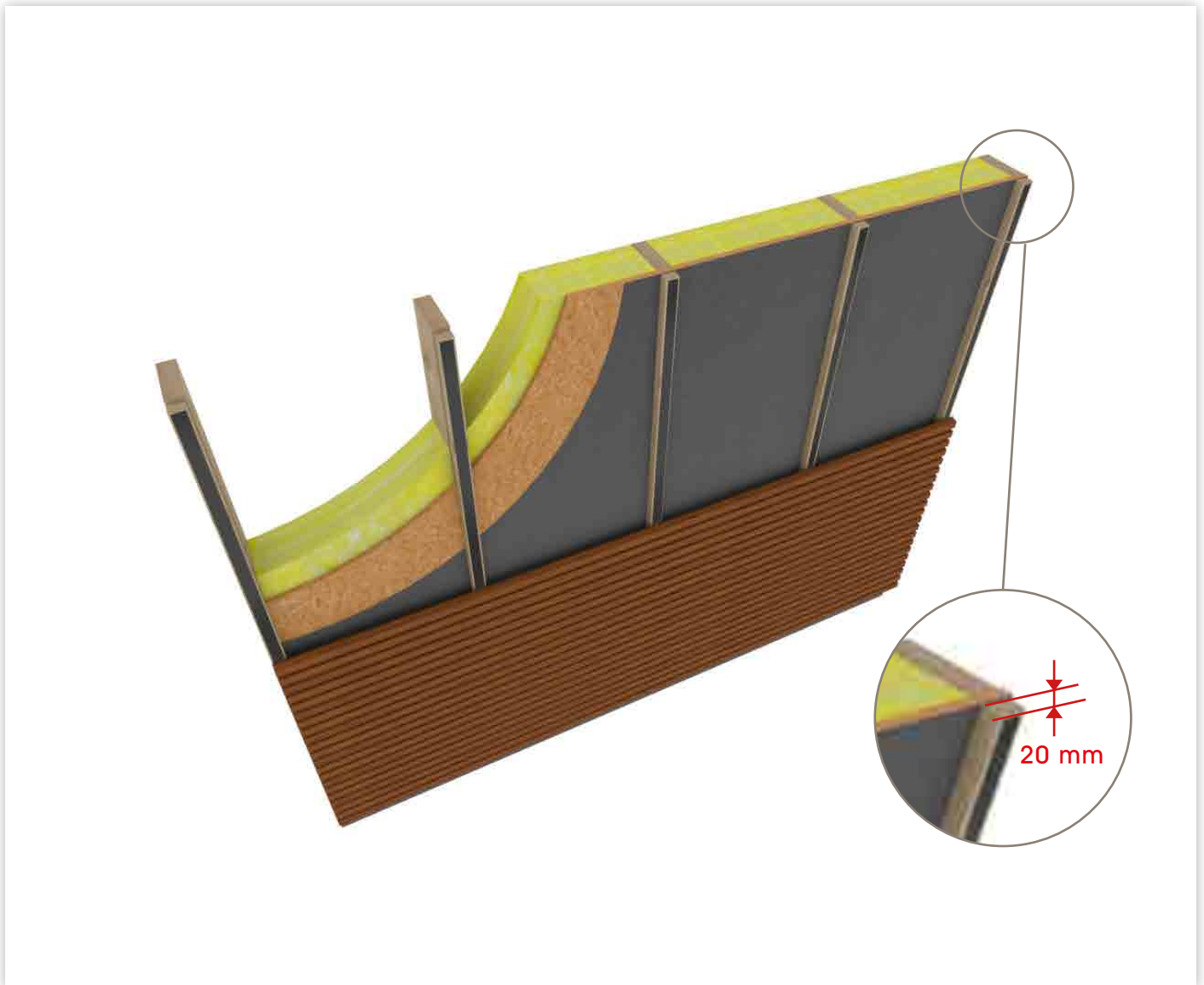

5 - INSTALLATION ON METAL FRAMEWORK

5.1 - HORIZONTAL INSTALLATION

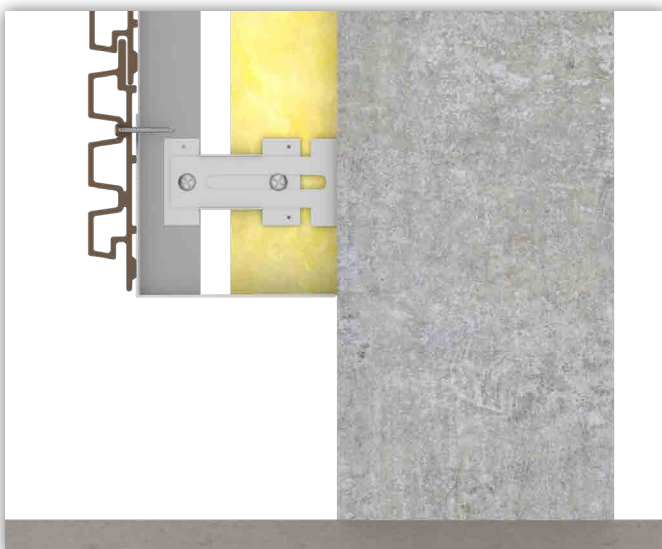
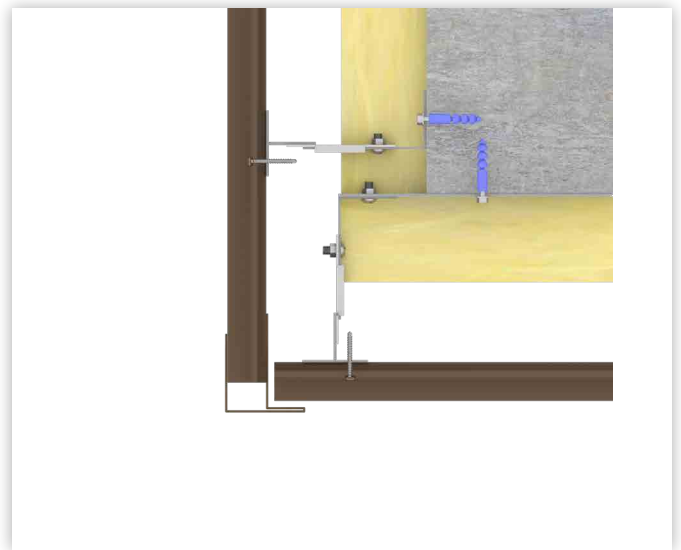
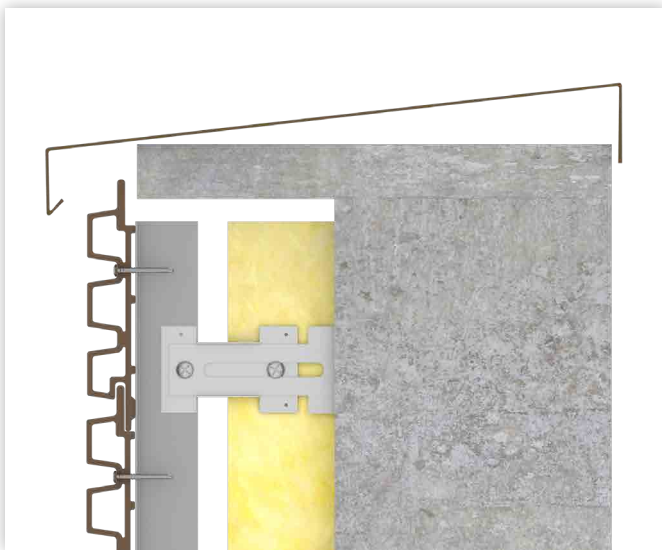
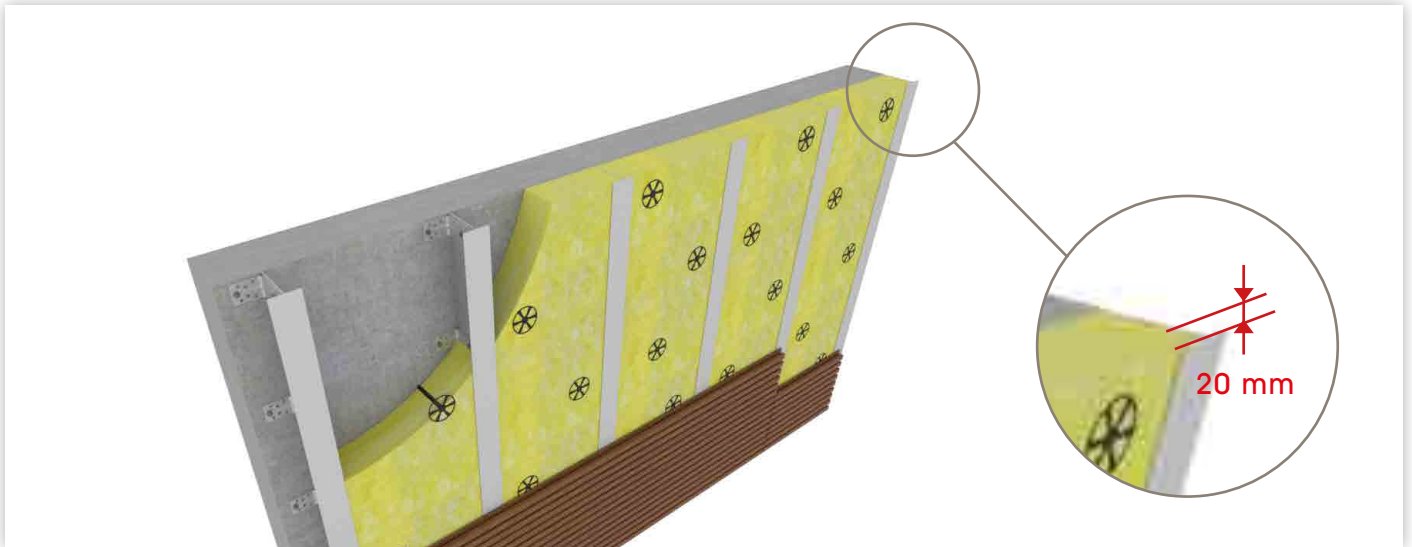

5 - INSTALLATION ON METAL FRAMEWORK

5.2 - VERTICAL INSTALLATION

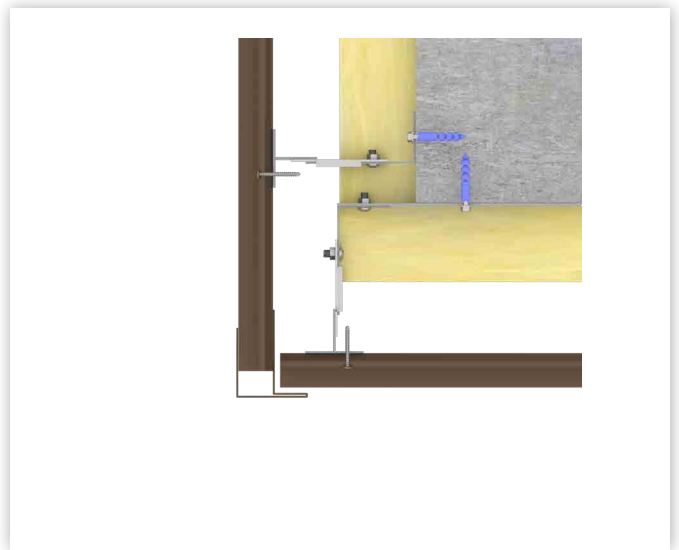
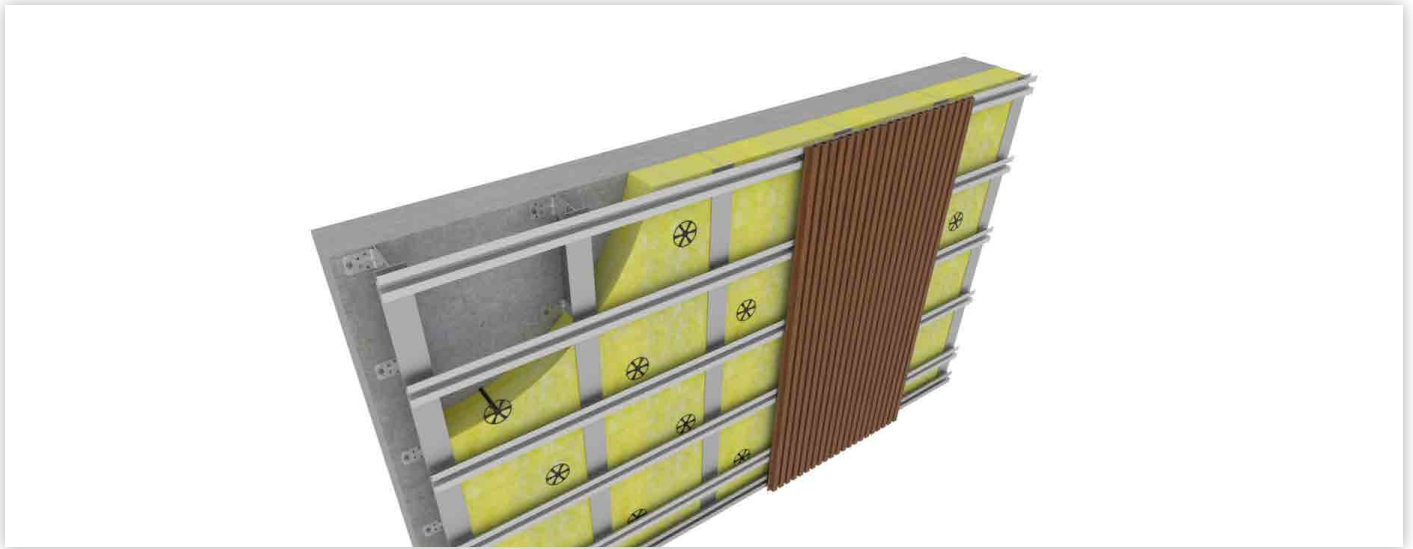

Fiberdeck[®]

www.fiberdeck.com